



**Università degli Studi di Ferrara**

**DOTTORATO DI RICERCA IN  
BIOCHIMICA, BIOLOGIA MOLECOLARE  
E BIOTECNOLOGIE**

**COORDINATORE PROF. FRANCESCO BERNARDI**

**HLA-G MOLECULES: FROM EMBRYO IMPLANTATION  
TO OOCYTE MATURATION**

**DOTTORANDA**

DOTT.SSA ROBERTA RIZZO

**TUTORE**

PROF. OLAVIO BARICORDI

**XXI° CICLO**

**ANNI 2006 - 2008**

It is not because things are difficult  
that we do not dare,  
it is because we do not dare  
that they are difficult.

*Seneca*

The present thesis is based on the following publications:

- I. This thesis is submitted to *Expert Review Obstet. Gynecol.* (2009).
- II. Rizzo R, Baricordi OR. HLA-G expression and regulation in early embryos. *Am. J. Reprod. Immunol.* 56 (1): 17 (2006).
- III. Hviid TVF, Rizzo R, Melchiorri L, Stignani M, Baricordi OR. Polymorphism in the 5'-upstream regulatory and 3'-untranslated regions of the HLA-G gene in relation to soluble HLA-G and IL-10 expression. *Human Immunol.* 67 (1-2), 53-62 (2006).
- IV. Rizzo R, Melchiorri L, Stignani M, Baricordi OR. HLA-G expression is a fundamental prerequisite to pregnancy. *Human Immunol.* 68 (4), 244-250 (2007).
- V. Rizzo R, Fuzzi B, Stignani M, Criscuoli L, Melchiorri L, Dabizzi S, Campioni D, Lanza F, Marzola A, Branconi F, Noci I, Baricordi OR. Soluble HLA-G molecules in follicular fluid: a tool for oocyte selection in IVF? *J. Reprod. Immunol.* 74 (1-2), 133-142 (2007).
- VI. Baricordi OR, Stignani M, Melchiorri L, Rizzo R. HLA-G and inflammatory diseases. *Inflamm. Allergy Drug Targets.* 7 (2), 67-74 (2008).
- VII. Borgatti M\*, Rizzo R\*, Canto MB, Fumagalli D, Renzini MM, Fadini R, Stignani M, Baricordi OR, Gambari R. Release of sICAM-1 in oocytes and in vitro fertilized human embryos. *PLoS ONE* 3 (12), e3970 (2008).  
\*The first two authors contributed equally to the work.
- VIII. Rizzo R, Stignani M, Amoudruz P, Nilsson C, Melchiorri L, Baricordi O, Sverremark Ekstrom E. Allergic women have reduced sHLA-G plasma levels at delivery. Submitted to *Am. J. Immunol.* (2008).
- IX. Rizzo R, Dal Canto MB, Stignani M, Fadini R, Fumagalli D, Mignini Renzini M, Borgatti M, Gambari R, Baricordi OR. Production of sHLA-G molecules by "in vitro" matured cumulus-oocyte complex. Submitted to *J. Reprod. Immunol.* (2008).

## **Preface**

The work included in this thesis was performed during my Ph.D. studies at the Department of Experimental and Diagnostic Medicine – Section of Medical Genetics.

First of all I am grateful to Professor Olavio Baricordi who have introduced me to the research and offered me many opportunities. Warm thanks to my labmates with whom I have been sharing everyday life and all the excitements and disappointments of the research. I heartly thank Lory for her advices and sincere friendship; Marina for constructive talks, not only about work, and for keeping me in touch with molecular biology; Teresa for her resourceful helpfulness; Alessandra for her support. Beyond strictly scientific matters, I am heartly grateful to all these people for their friendship.

This thesis would never have been possible without the constant support of a number of collaborators. A very special thank is given to Dr. Thomas Hviid, from the Department of Clinical Biochemistry of the Roskilde University with whom I have had many good discussions; to Professor Gambari and Dr. Monica Borgatti from the Biochemistry and Molecular Biology of the University of Ferrara and to Dr. Lanza and Dr. Diana Campioni from the Hematology of the University of Ferrara, for the idea exchanges and technical support.

Finally, and most of all, I want to thank my family, Mum, Dad and Stefano, for their support and understanding. I want to share with them the joy of this event of my life.

Roberta Rizzo

# Contents

	Pages
<b>HLA-G molecules in ART: from embryo implantation to oocyte maturation .....</b>	<b>1</b>
<b>Introduction</b>	
1. Actual problems of ART .....	2
2. Human Major Histocompatibility Complex .....	3
3. The non classical HLA class Ib genes .....	4
4. The HLA-G antigen .....	4
4.1. The <i>HLA-G</i> gene .....	4
4.2. HLA-G expression and function .....	8
5. HLA-G and pregnancy .....	12
5.1. HLA-G and trophoblasts .....	15
5.2. HLA-G and embryo .....	18
5.3. HLA-G and oocyte .....	27
<b>Conclusions and perspectives</b>	
6. Expected HLA-G impact in ART.....	32
7. Expert commentary .....	32
8. Five-year view .....	33
Key issues .....	34
Acknowledgments .....	35
References .....	35
Abstract .....	48
Riassunto (Abstract in Italian) .....	57
Article II-IX .....	66



# **HLA-G molecules in ART: from embryo implantation to oocyte maturation**

Roberta Rizzo†

Department of Experimental and Diagnostic Medicine – Section of Medical Genetics  
– University of Ferrara, Ferrara (Italy)

**Running title:** HLA-G molecules in ART

†Author for correspondence

Department of Experimental and Diagnostic Medicine – Section of Medical Genetics  
– University of Ferrara – Via Luigi Borsari 46 – 44100 Ferrara – Italy

Tel ++390532455383

Fax ++390532455380

e-mail [rbr@unife.it](mailto:rbr@unife.it)

## **Abstract**

Pregnancy is commonly considered a semi-allograft as half of the fetal genome derives from the father. However in normal pregnancy several tolerance mechanisms have been demonstrated to counteract the maternal immune response. Among these, the expression of HLA-G by invasive cytotrophoblasts has shown to play a fundamental role in creating a tolerogenic condition at the feto-maternal interface. The possible role of soluble HLA-G molecules as a marker for oocyte/embryo selection is reviewed comparing the contrasting results present in the literature and the significance of HLA-G modulation in assisted reproduction.

**Key words:** assisted reproduction, HLA-G, embryo, oocyte, marker

## **1. Actual problems of ART**

The present efficiency of assisted reproduction (ART) seems to be far from desired. Until now the probability of a successful pregnancy following an *in vitro* fertilization procedure (IVF) is approximately 18%, with a baby rate of at about 14%. Since the birth of the first baby created by ART, Louise Brown in England in 1978 [1], it has produced more than 40,000 ART babies each year. However the average success rate is still low because of the inability to assess embryo quality using the currently available biochemical, genetic and imaging methods. At the present time it is not possible to determine for sure the best oocyte to fertilize or the most appropriate embryo to transfer. Therefore the usual practice is to transfer two or three embryos to improve the chance of a positive pregnancy outcome. Women undergoing ART have a 20-fold increased risk of twins and a 400-fold increased risk of triplets or higher order pregnancies with a perinatal mortality and morbidity [2,3]. Several studies are involved in the identification of non-invasive methods to determine the oocyte/embryo quality to allow fewer embryos to be transferred while maintaining or



improving pregnancy rates. Since the beginning of this new century the value of non classical HLA (Human leukocyte antigen) class I – G antigen as a marker of oocyte/embryo competency is under debate.

## 2. Human Major Histocompatibility Complex

The human Major Histocompatibility Complex (MHC) is a set of molecules encoded by a series of genes (~130) located on the short arm of chromosome 6 that are responsible for lymphocyte recognition, "antigen presentation" and immune response regulation. This gene complex comprises several distinct loci, grouped closely together on a 4-6 Mb chromosomal segment. In humans they are called HLA for Human Leucocyte Antigens. These antigens can be subdivided into three major classes: class I, class II and class III (**Figure 1**). The class I and class II antigens are expressed on cells and tissues whereas class III antigens are mainly serum and body fluid proteins (*e.g.* C4, C2, factor B, TNF, complement components). The class I gene complex contains three major loci A, B and C. Each of these loci encodes for an alpha-chain polypeptide that associates to  $\beta$ 2-microglobulin, encoded by a gene on chromosome 15. The class II gene complex contains at least three loci, DP, DQ and DR; each of these loci encodes for one alpha- and one beta-chain polypeptide which associate together to form the class II antigens. Since the end of the 80's a new group of antigens has become interesting: the non classical HLA class I molecules [4,5].

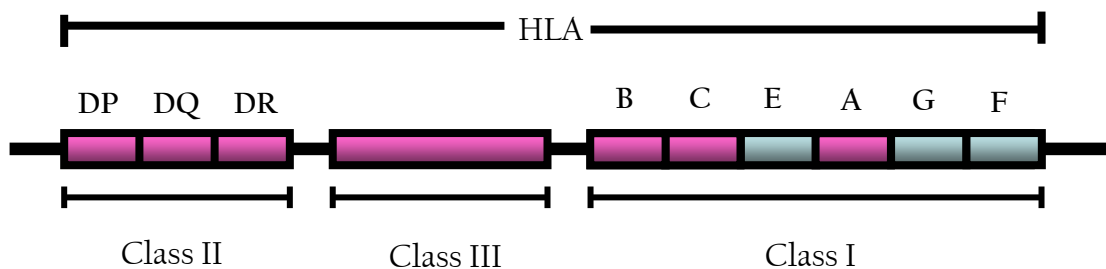

**Figure 1. Schematic representation of the HLA region on chromosome 6.** The non classical HLA class I gene are represented in grey.

### **3. The non classical HLA class Ib genes**

Non-classical MHC class Ib molecules are closely homologous to classical class Ia molecules but are distinguished by their limited polymorphism and low cell surface expression. The class Ib molecules are not just vestigial evolutionary remnants of classical class Ia molecules; rather some are involved in highly specialized roles, as testified by their conservation between different species. The duo comprised of HLA-E in human, Qa-1 in mouse and HLA-G in human, Qa-2 in mouse constitutes a clear homology between species. In 1993, Warner et al. [6] demonstrated a reproductive advantage in mice encoding Qa-2 molecules by preimplantation embryo development (Ped) gene, the homologue of human HLA-G gene. The Qa-2 antigen has been detected on murine oocytes and early-cleavage and blastocyst-stage embryos where it seems to function as a mediator of mitogenic signals between embryo and uterine environment [7]. For these characteristics, Qa-2 and HLA-G antigens seem to share not only structural but also functional similarities in the regulation of immune response, through interaction with both inhibitory and activatory receptors [8,9].

### **4. The HLA-G antigen**

HLA-G antigen is a non-classical HLA class I molecule characterized by (i) a low allelic polymorphism, (ii) a restricted tissue distribution to trophoblasts and a subset of thymic epithelial cells, (iii) mRNA alternative splicing that generates seven proteic isoforms and (iv) a tolerogenic and anti-inflammatory biological function [10].

#### **4.1. The *HLA-G* gene**

The *HLA-G* gene features low allelic polymorphisms with 36 HLA-G alleles acknowledged in the coding region (<http://www.anthonynolan.org.uk/HIG/>). *HLA-G* gene is also polymorphic at the 5'-upstream regulatory region (5' URR) and at the 3'-untranslated region (3' UTR) which may contribute to the regulation of *HLA-G*

expression [11]. A 14 bp insertion/deletion polymorphism (rs16375) in exon 8 in the 3' UTR has been reported and associated with mRNA stability and HLA-G protein expression [12,13] (**Figure 2**). The allele with an insertion of 14 bp has been associated with lower levels of HLA-G expression than the allele with the 14 bp deleted [13-15]. An additional alternatively spliced *HLA-G* transcripts lacking 92 bp of the first part of exon 8 is observed within the insertion of 14 bp allele and is characterized by a more stable transcript [16].

Transactivation of classical MHC class I genes is mediated by two groups of juxtaposed cis -acting regulatory modules: (i) the up-stream enhancer A and ISRE (interferon-sensitive response element) which mediate the constitutive and cytokine-induced expression; (ii) the S-X-Y module which controls the constitutive and CIITA (class II transactivator) mediated transactivation. These modules are divergent in *HLA-G* gene that is unresponsive to NF-kappaB (nuclear factor-kappaB), IRF-1 (interferon regulatory factor 1), and CIITA mediated induction pathways [17]. The *HLA-G* gene promoter shows a putative interferon-regulatory factor (IRF)-1 binding site 746 base pairs upstream from ATG, which is distinct from the interferon-responsive element within proximal class Ia gene promoters. This control region is the putative element which mediates interferon beta-induced expression of the *HLA-G* gene [18]. The *HLA-G* promoter contains three cAMP/PMA response elements (CRE/TRE) with binding affinity for REB (rice endosperm bZIP)/ATF (activating transcription factor-2) and Fos/Jun proteins. It has been shown that *HLA-G* transactivation is regulated by CREB (cAMP-response element-binding protein), CREB-binding protein (CBP), and p300. These features represent the unique regulation of *HLA-G* transcription among the MHC class I genes [19].

Epigenetic mechanisms seem to play an important role in *HLA-G* expression [20,21]. The potential role of DNA methylation on *HLA-G* expression has been tested in human tumours considering the effect of the methylation inhibitor 5-azadeoxycytidine on the CpG-enriched regulatory region of the *HLA-G* gene. The 5-aza-dC treatment results in hypomethylation of putative control sequences within the 5'

regulatory region of *HLA-G* and these changes in methylation correlate with a significant increase in expression.

The *HLA-G* gene seems not to undergo genomic imprinting, in fact it is co-dominantly expressed on trophoblast cells [22].

A post-transcriptional regulation for HLA-G molecules is also possible because of the expression in advance of the molecules that are essential for cell surface expression of class I molecules,  $\beta_2$ -microglobulin ( $\beta_2m$ ) and the transporter for antigen processing proteins (TAP1 and TAP2), allowing a rapid accumulation of HLA-G protein in differentiating extravillous cytotrophoblast cells [23].

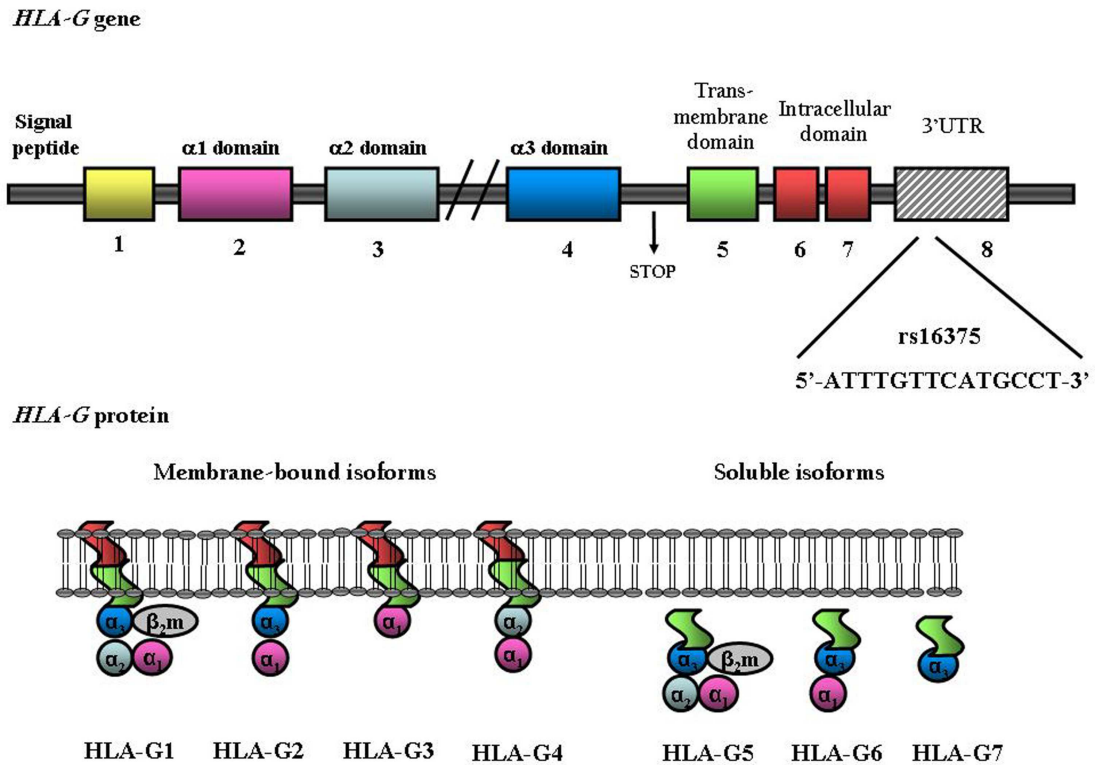

**Figure 2. Multiple HLA-G proteins derived from alternative splicing of HLA-G mRNA.**

Upper: The *HLA-G* gene is composed of 8 exons. The  $\alpha$ , intracellular and transmembrane domains and the 14 bp insertion/deletion polymorphism (rs16375) in exon 8 in the 3' untranslated region (UTR) are represented. The gene is alternatively spliced to yield 7 transcripts. In two of these, a stop sequence in intron 4 results in soluble isoforms.

Lower: The 7 HLA-G proteic isoforms: four membrane-bound (HLA-G1, -G2, -G3, -G4) and three soluble (HLA-G5, -G6, -G7) molecules.

## 4.2. HLA-G expression and function

In physiological conditions HLA-G protein presence is restricted to trophoblasts, thymus, cornea, nail matrix, pancreas, erythroid and endothelial precursors [24].

Unlike HLA class Ia antigens, seven HLA-G isoforms are generated by alternative splicing of its primary transcript. Four of them, HLAG1,-G2, -G3 and -G4, are membrane-bound, while three, HLA-G5, -G6 and -G7, are soluble molecules (**Figure 2**). The soluble isoforms retain the intron 4 which includes a stop codon and leads to the termination of the mRNA translation before the transmembrane domain. The HLA-G1 and HLA-G5 structures are characterized by three alpha domains, differently from the other isoforms which lack one or more globular domain. The most analyzed isoforms are HLA-G1 and HLA-G5 antigens. The proteolytical cleavage of surface isoform HLA-G1 generates the soluble HLA-G1 form (sHLA-G1) [25].

An in frame termination codon in *HLA-G* exon 6 leads to a truncated cytoplasmic tail which is 19 amino acids shorter than the corresponding tails of HLA-A, -B and -C proteins. This feature prevents the signal transduction from the cell surface to the nucleus. However, the membrane-bound HLA-G can localize in lipid rafts and can act as a signaling molecule, via modification of the phosphorylation state of raft-localized proteins [26].

The HLA-G production up-regulation is controlled by interleukin (interleukin-10), interferon and hormone molecules [13].

Membrane-bound HLA-G1 and soluble HLA-G (HLA-G5 and sHLA-G1) molecules exert immunosuppressive effects: (i) inhibit the cytotoxic activity of CD8 positive T lymphocytes (CTL) and Natural Killer (NK) cells [27], (ii) induce the apoptosis of NK and activated cytotoxic T cells [28], (iii) inhibit the allogeneic CD4 positive T-cell proliferation and interfere with naïve CD4 T-cell priming [29], (iv) inhibit antigen presenting cell and B lymphocyte differentiation [30], (v) induce regulatory T cells [31] (**Figure 3**). Furthermore, sHLA-G affects angiogenesis interacting with

endothelial cells [32] and induces resting NK cells to produce chemokines and cytokines [8].

The functions of HLA-G molecules are due to their ability to act as a ligand for different receptors expressed by immune cells (**Figure 3**). HLA-G interacts with NK receptor KIR2DL4 [8] and leukocyte inhibitory receptors (LILRs) / immunoglobulin-like transcripts (ILT) [9] as LILRB1 (LIR-1/ILT2/CD85j), which is highly expressed on T and B lymphocytes and with LILRB2 (LIR-2/ILT4/CD85d), present mainly in monocytes/macrophages. The alpha3 domain of HLA-G is the putative binding site for ILT receptors [33] while the residues Met76 and Gln79 in the alpha1 domain play a critical role in the recognition of KIR2DL4 receptor [34].

Soluble HLA-G has potentially a higher range of activity than membrane-bound HLA-G. The circulating isoforms could bind to the same sets of leukocytes and perform exactly the same functions also systemically.

The membrane-bound and soluble HLA-G proteins have monomer, dimer, and oligomer forms; the dimer seems to have a dominant effect on the LILRB signaling. Dimers of HLA-G have been observed on the surface of transfected cells [35], on choriocarcinoma cell line JEG-3 [36] and on first trimester trophoblast cells [37]. A disulfide-bonded dimer conformation is possible for the presence of a cysteine 42 residue that is present only in the heavy chain  $\alpha 1$  domain of HLA-G [33,35].

Soluble HLA-G1 is able to inhibit endothelial cells through specific interaction with the CD160 molecule, a glycosylphosphatidylinositol-anchored, major histocompatibility complex (MHC) Class I-dependent, immunoglobulin-like receptor, that is expressed by activated endothelial cells [32] (**Figure 3**). This interaction seems to lead to apoptosis of endothelial cells required for normal placental development.

HLA-G molecules undergo the trogocytosis mechanism: some effectors CD4 and CD8 T lymphocytes acquire immunosuppressive HLA-G1 molecules from antigen presenting cell membranes and reverse their function from effectors to regulatory cells [38].

The HLA-G expression has been analyzed in different pathological conditions, such as transplantation, oncology, viral infections, inflammatory and autoimmune diseases indicating that HLA-G can favour graft tolerance, tumor cell and virally infected immune escape and control the inflammatory conditions [39].

**Figure 3. HLA-G receptors.** HLA-G receptors expressed on immune (CD8 T and CD4 T cells, B cells, natural killer (NK) cell, macrophages, dendritic cells) and endothelial cells. ILT: immunoglobulin-like transcript; KIR: killer inhibitory receptor; TCR: T cell receptor.



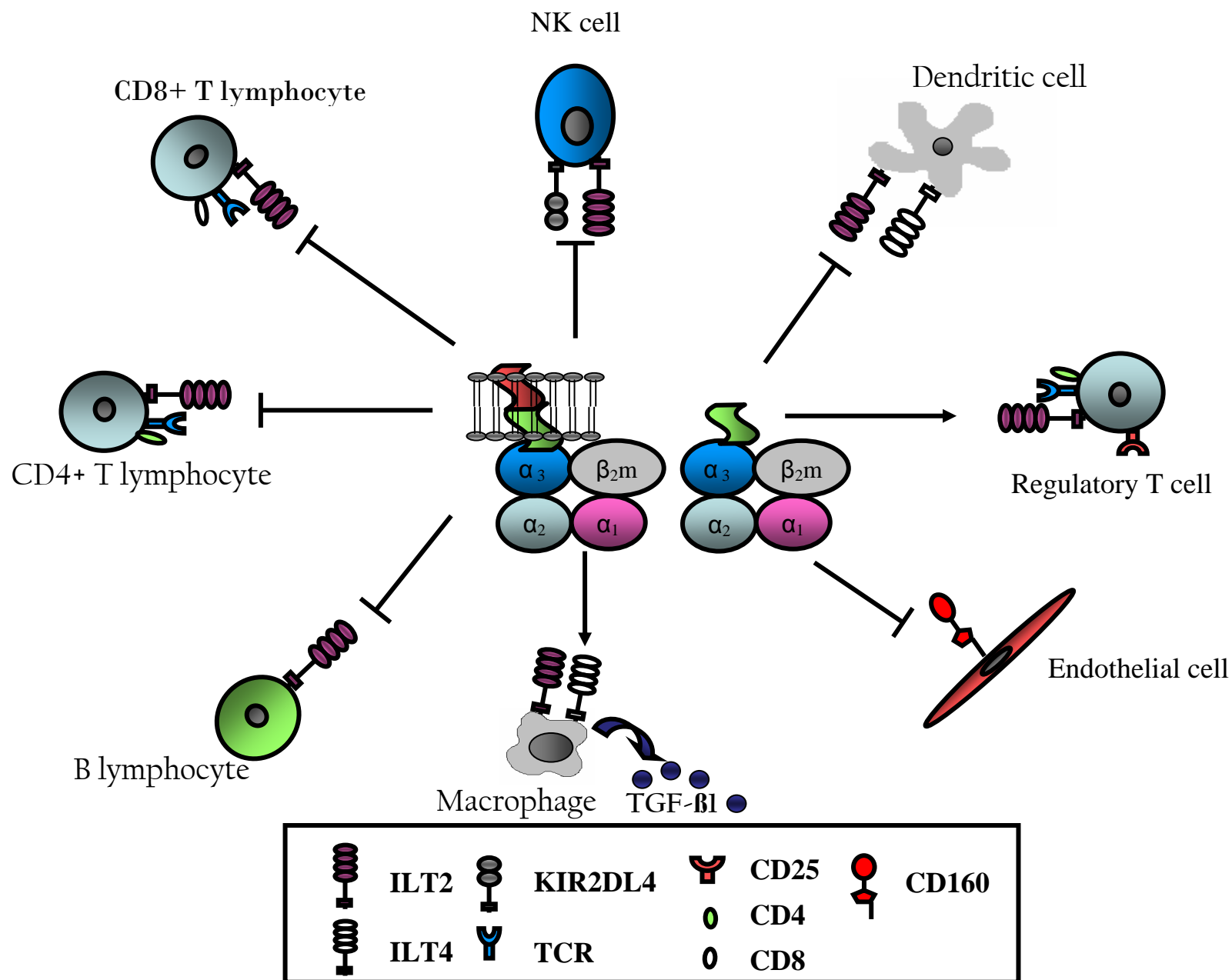

## 5. HLA-G and pregnancy

Pregnancy is commonly considered a paradox. In an outbreed population, half of the fetal genes are paternal, thus the fetus may be considered a semi-allograft. However in normal pregnancy the maternal immune system does not reject the fetus, even if it is a “stranger in a strange land” [40], as a series of tolerogenic mechanisms are developed to allow gestation and birth of healthy babies.

The enigma of the absence of fetal rejection was stated in 1953 by Sir Peter Medawar. He proposed the presence of protective mechanisms that could stimulate the tolerance in the mother [41]. Especially, the absence of HLA class I and II molecules modulation and the production of immuno-suppressant soluble molecules (progesterone, prostaglandine, transforming growth factor- $\beta$ 1, Interleukin-10) [42] by the fetal tissues strongly confirm the development at the feto-maternal interface of tolerogenic conditions.

Recently a fundamental role in maintaining this tolerogenic condition has been proposed for HLA-G antigens. The soluble HLA-G molecules have been detected in the plasma of pregnant women with increased levels during the first trimester in comparison to non-pregnant women [43] (**Table 1**). On the contrary sHLA-G plasma levels decrease during the third trimester [44,45] while it has an impressive boost at delivery [46] probably deriving from the shedding of placental membrane-bound HLA-G molecules.

sHLA-G concentrations in serum/plasma of pregnant women have been associated with clinical outcome. sHLA-G levels in plasma from women who subsequently develop preeclampsia, a potentially dangerous disorder of human pregnancy associated with utero-placental vascular defects [47], and/or intrauterine growth retardation (IUGR) are lower than those in control pregnant women, in the first, second [43,45] and third trimesters [48]. Women with in vitro fertilization (IVF) failure manifested by spontaneous abortion in the early pregnancy present lower sHLA-G in the pre-ovulation period and during pregnancy compared to women with normal pregnancies [49].

The reduction of HLA-G molecules could disregulate uterine natural killer (uNK) cells which are supposed to participate in the process of placentation and in uterine spiral artery transformation. Soluble HLA-G may contribute to trigger functional maturation of the uNK cells and vascular remodelling and decidualization. The reduced release of sHLA-G into the maternal circulation in preeclampsia and IUGR may alter the maternal-fetal immune relationship and thus be involved in the cause of these disorders.

**Table 1.** Published studies of HLA-G expression in serum of normal and pathological pregnant women.

PE: preeclampsia; IUGR: intrauterine growth retardation

Study (year)	Sample	Technique	MoAb	Results
<b>Normal condition</b>				
<b>Hunt JS</b> Am J Obstet Gynecol 2000	Serum 44 non pregnant women 129 pregnant women	ELISA	16G1, 16A1	sHLA-G higher in pregnant women
<b>Hackmon R</b> Fetal Diagn Ther. 2004	Serum 21 pregnant women 16-20 weeks 19 women at term	ELISA	87G, 16G1	sHLA-G lower toward term
<b>Yie SM</b> Am J Obstet Gynecol (2005)	Serum 12 pregnant women first, second, third trimesters	ELISA	4H84, 3C/G4	sHLA-G decrease in third trimester pregnant women
<b>Steinborn A</b> Am J Reprod Immunol (2007)	Plasma 40 non pregnant women 291 pregnant women	ELISA	MEM-G9	sHLA-G increase in first trimester pregnant women
<b>Rizzo R</b> Am J Reprod Immunol (2009)	Plasma 43 Pregnant women third trimester, at delivery	ELISA	MEM-G9	sHLA-G increase at delivery
<b>Pathological condition</b>				
<b>Pfeiffer KA</b> Hum Immunol (2000)	Serum 65 IVF patients preovulatorily, after a positive HCG test weekly until the 9th gestational week	ELISA	TP25.99 depletion W6/32	sHLA-G decrease in the pre-ovulation period and during pregnancy in women with a spontaneous abortion in IVF
<b>Yie SM</b> Am J Obstet Gynecol (2005)	Serum 12 pregnant women and 12 PE women first, second, third trimesters	ELISA	4H84, 3C/G4	sHLA-G decrease in first trimester preeclamptic women
<b>Steinborn A</b> Am J Reprod Immunol (2007)	Plasma 40 non pregnant women 291 pregnant women first, second, third trimesters 236 PE/IUGR pregnant women first, second, third trimesters	ELISA	MEM-G9	sHLA-G decrease in second trimester preeclamptic women
<b>Hackmon R</b> Am J Obstet Gynecol (2008)	Serum 24 pregnant women third trimester 26 PE pregnant women third trimester	ELISA	MEM-G9	sHLA-G decrease in third trimester preeclamptic women

### 5.1. HLA-G and trophoblasts

The trophoblast differentiates into extravillous and villous tissues where extravillous cytotrophoblast (evct) cells invade the deciduas while villous cytotrophoblasts (vct) produce the outer villous syncytiotrophoblast (st) layer of chorionic villi (**Figure 4**). None of these villous trophoblast populations constitutively express HLA-A and -B at their surface. The absence of classical HLA class Ia molecules in cytotrophoblast cells, except for HLA-C, could activate NK cells towards fetal tissues. This is not the fact as the NK cells cytotoxicity is controlled by the interaction of HLA-C and HLA-G molecules with inhibitory receptors. The HLA-C1 group interacts with inhibitory KIR receptors 2DL2 and 2DL3, while the HLA-C2 group interacts with 2DL1 inhibitory receptor. HLA-G antigens interact with KIR2DL4 NK receptor [50] inducing proliferation and interferon (IFN)- $\gamma$  secretion which might contribute to implantation and decidualization during early pregnancy [51].

HLA-G has been firstly detected in placenta by Ellis et al. [52] who have reported an HLA-G expression in chorionic membrane (extravillous) cytotrophoblast cells and in term amniochorion and trophoblast cells (**Table 2**). HLA-G has been observed in all types of extravillous cytotrophoblasts, with an increased gradient of expression from the villi into the deciduas [53]. Non-trophoblastic HLA-G expression has been detected in Hofbauer cells in the mesenchymal core of chorionic villi [54] and in endothelial cells [55]. An RNase protection assay and quantitative RT-PCR studies have indicate that the full-length transmembrane form of HLA-G (HLA-G1) is the predominant splice variant transcribed in vivo by trophoblasts and it is mainly expressed as a disulphide-linked homodimer [37]. Soluble HLA-G might derive from transmembrane HLA-G1 molecules and from HLA-G5 transcript [56-58]. Some investigators have failed to report HLA-G5 in villous placenta [59] underlining some differences in the results obtained by different research groups. It is of interest the work by Ishitani et al. [56] and Le Maoult et al. [58] which have verified the presence of HLA-G5 isoform by blocking the staining with 16G1 monoclonal antibody (moAb) by the addition of the 20-mer synthetic peptide and using a new anti-HLA-

G5/-G6 moAb called 5A6G7 respectively. However these discrepancies are still to be resolved.

The importance of HLA-G presence in placental trophoblasts is evident in preeclampsia (**Table 2**), that is characterized by a defect in placental membrane and soluble HLA-G expression [60,61], where the absence of HLA-G molecules has an effect on fetal protection and vascular events.

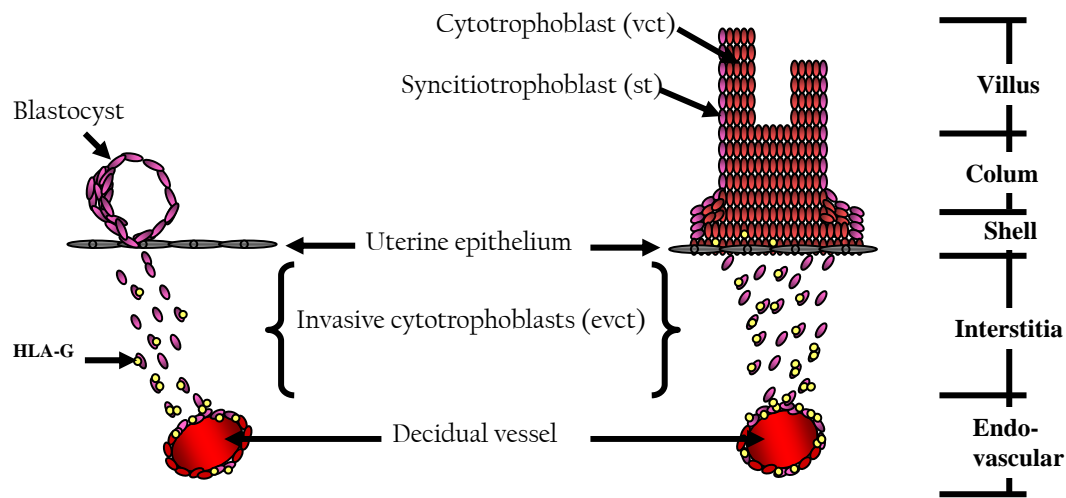

**Figure 4. HLA-G expression by cytotrophoblast cells in the early gestation.** Placental villus, trophoblastic column, trophoblastic shell and deciduas are represented. HLA-G is expressed by invasive cytotrophoblast cells.

**Table 2.** Published studies of HLA-G expression in trophoblast cells of normal and pathological pregnant women.

<b>Study (year)</b>	<b>Sample</b>	<b>Technique</b>	<b>MoAb</b>	<b>Results</b>
<b>Normal condition</b>				
<b>Ellis SA</b> Immunology (1986)	Amniochorion cytotrophoblast	Immunoflorescence SDS-PAGE Isoelectric focusing	W6/32 BBM.1	Novel HLA Class I molecule on chorionic cytotrophoblast cell membranes
<b>Ishitani A</b> J Immunol (2003)	First trimester placenta (5–12 wk of gestation) and normal term placentas (37–39 wk of gestation)	ELISA Immunohistochemical staining Western analysis	87G 01G 16G1	Membrane HLA-G in extravillous trophoblasts, soluble HLA-G in all placental trophoblasts
<b>Morales PJ</b> J Immunol (2003)	First trimester and term placentas	Immunohistochemical staining	1-2C3 (G1) 26-2H11 (G2)	sHLA-G1 and m/s-G2 are produced in placentas m/sHLA-G2 present in the invasive trophoblast
<b>Blaschitz A</b> Mol Hum Reprod (2005)	Term placentas	RT PCR Immunohistochemistry and immunocytochemistry ELISA Western blot analysis	MEM-G/1 4H84	Trophoblasts express only the HLA-G1 isoform
<b>LeMaoult J</b> Mol Hum Reprod (2005)	First-trimester extravillous cytotrophoblast	Immunohistochemistry	5A6G7	HLA-G5 expressed by extravillous cytotrophoblasts
<b>Apps R</b> Eur J Immunol (2007)	Decidual and placental tissues from first-trimester pregnancies	Immunoblotting Flow cytometry	G233 87G MEM-G/11	HLA-G - b2m-associated dimers expressed by trophoblasts
<b>Pathological condition</b>				
<b>Goldman-Wohl D</b> Mol Hum Reprod (2000)	First, second trimesters and term placentas 12 uncomplicated pregnant women 10 PE pregnant women	RNA in-situ hybridization	NA	HLA-G mRNA expression defective in most preeclamptic placentae
<b>Yie SM</b> Am J Obst Gyn (2004)	Term placentas 14 uncomplicated pregnant women 20 PE pregnant women	Western Blot lysate	4H84	Reduced HLA-G protein in PE placentas

## 5.2. HLA-G and embryo

The first demonstration of HLA-G expression in preimplantation human embryos has been obtained by Jurisicova et al. [62] by RT-PCR and immunocytochemistry techniques (**Table 3**). The authors have shown the presence of a HLA-G heavy chain specific mRNA in about 40% of the 148 blastocysts tested. They have also reported that HLA-G mRNA is present in all preblastocyst development stages, including 2- to 4-, 5- to 8-, and 9- to 16-cell embryos and morulas. The detection of HLA-G specific mRNA in preimplantation embryos has been confirmed by protein detection at cell membrane level and by an increased blastocystic cleavage rate when compared to embryos without HLA-G transcripts [63]. Yao et al. [64] have confirmed that human preimplantation embryos express HLA-G mRNA with some difficulties at the earliest stages but with an increasing proportion of positive embryos with developmental stage. The predominant isoform is HLA-G3 and -G4 while the full-length membrane bound (G1) and soluble forms (G5) and the truncated G2 and G6 vary in their expression, with G1 mRNA present in the 80% of blastocysts, soluble G5 in the 20% and soluble G6 in the 32%. Hunt et al. [65] have demonstrated that preimplantation human embryos express HLA-G5 but not HLA-G6 isoforms using specific HLA-G5 and -G6 moAbs [57]. These results are in striking contrast with mRNA data supporting the hypothesis of a gestational post-transcriptional programming of HLA-G isoforms. On the contrary Desoye et al. [66] have been unable to show a HLA-G staining on three unfixed polyploid embryos at the 2-, 5-, and 8-cell stages; Roberts et al. [67] have not detected HLA-G on three blastocysts and Hiby et al. [68] have found no HLA-G mRNA in 11 preimplantation embryos ranging from the 2 cell to the blastocyst stage using nested primers for full-length HLA-G. These contrasting data on HLA-G expression during the critical period of preimplantation embryonic development could be explained by differences in methodology and quality of the embryos used. Hiby et al. [68] have isolated mRNA from zona intact embryos with a standard phenol-chloroform extraction and a nested RT-PCR for full-length HLA-G with the outside forward primer located at exon 3 and the reverse primer at 3' UTR, the inside forward primer located at exon 5, and the reverse primer at 3' UTR. These



primer sets cannot amplify HLA-G2 and -G3 isoforms because G2 lacks exon 3 and G3 lacks exon 3 and 4. On the contrary Yao et al. [64] have isolated mRNA with high performance magnetic beads removing the zona first. The quality of the embryos could be a possible reason for these different results. Yao et al. [64] have used only good-quality diploid embryos (grade A–C embryos and grade 4 blastocysts), which was not the case in previous studies [66].

The discrepancies obtained with embryo immunostaining for HLA-G molecules could be explained by the differences in methodology and the quality of the embryos used. Previous studies have used unfixed [66], acetone fixed [67], and paraformaldehyde fixed embryos [62,63] and a primary Ab incubation time between 30 min and 1 h. Yao et al. [64] and Shaikly et al. [69] have used the HLA-G-specific moAb MEMG/9 on fixed and permeabilized embryos, revealing both cytoplasmic and surface expression and prolonged overnight the Ab incubation to increase the sensitivity of the technique.

Shaikly et al. [69] have found a stronger HLA-G staining on the trophoctoderm of blastocysts, reinforcing the hypothesis of an implication of HLA-G in early implantation of the embryo in the maternal uterus.

**Table 3.** HLA-G expression by preimplantation human embryos.

Study (year)	N. cultures	N° positive embryos (%)	Culture media	Hrs post fertilization	Detection Antibody	Fixative
<b>Positive results</b>						
<b>Juriscova A</b> PNAS (1996)	ND	ND	Ham's F10	24-96	1B8	Paraformaldehyde fixed
<b>Yao YQ</b> J Immunol (2005)	20	15 (75)	IVF	24-144	MEM-G9	Fixed and permeabilized
<b>Shaikly VR</b> J Immunol (2008)	11	8 (73)	Sequential medium	48-72	MEM-G9	Fixed and permeabilized
<b>Negative results</b>						
<b>Desoye G</b> J Immunol (1988)	3	0	Ham's F 10	24-96	W6/32	Unfixed
<b>Roberts J</b> Immunol (1992)	3	0	Earle's solution	144-192	W6/32	Acetone fixed

The first non-invasive proof of non classical HLA-I expression by human early embryos was obtained in 1999 by Menicucci et al. [70]. They have demonstrated the presence of soluble HLA-G molecules (sHLA-G) in 90% of 8-cell stage embryo culture supernatants, obtained by ART. A significant association has been observed between HLA-G production and embryo cleavage rate. This study was confirmed by Fuzzi et al. in 2002 [71] (**Table 4**). The authors have presented the first *in vivo* proof of the role of HLA-G molecules in pregnancy implantation showing the presence of soluble HLA-G molecules in the supernatants from cultures containing one to four embryos. Two groups of patients have been identified on the basis of sHLA-G molecule presence or absence in the embryo culture supernatants. Although no clinical differences have been observed between the two groups, positive embryo implantation occurred only in women with sHLA-G molecules in embryo culture supernatants.

This study started wide ranging research on this topic [72,73]. Further reports [69,74-86] have analyzed the presence of sHLA-G molecules in the supernatants from single embryo cultures by enzymatic immunosorbent assay (ELISA) and HLA-G specific monoclonal antibodies (MEM-G1; MEM-G9; 4H84, 3C/G4). They have obtained a significant relationship between the secretion of these molecules by early embryos and a higher implantation/pregnancy rate with a significantly higher proportion of sHLA-G positive embryos developing to blastocysts *in vitro* [69,82]. The meta-analysis of eleven studies evaluating sHLA-G in embryo culture for predicting pregnancy outcome in women undergoing ART has reported a modest diagnostic accuracy (DOR: 4.38 (95% CI, 2.93-6.55)) while a subgroup analysis restricted to six studies with good quality embryos has shown an increase in the diagnostic performance (DOR: 12.67 (95% CI, 3.66-43.80)) [87]. These studies have investigated more than six thousand supernatants from single ART procedure embryos, with a recorded presence of sHLA-G from 36.2% [77] to 69.9% [80]. Shaikly et al. [69] have demonstrated a HLA-G specific labelling in the 50% of the twenty-four embryos analyzed with a distribution and intensity of fluorescence extremely variable.

Two main points should be focused on: **(i) the presence of positive pregnancy outcomes also in sHLA-G negative samples.** Sher et al. [75], Desai et al. [82] and Shaikly et al. [69] have reported significantly higher pregnancy rates when sHLA-G-positive embryos have been transferred but they have evidenced a pregnancy rate of 25-36% with sHLA-G-negative embryos. The absolute results of the first work by Fuzzi et al. [71], where all the positive pregnancies have been associated to sHLA-G positive embryo supernatants, could be ascribed to the presence of more embryos in each culture and/or to a different specificity of the detection assays. The different ELISA protocols used could account for different values and correlations of sHLA-G expression and implantation. Shaikly et al. [69] have confirmed the expression of sHLA-G in cleavage stage embryos during days 1 and 2 of human development but documented a marked variability of sHLA-G expression by early embryos from the same patient indicating a possible gestational embryo programming that could affect the results of sHLA-G and implantation correlation. However, sHLA-G-positive embryos have shown a higher rate of implantation in comparison with sHLA-G-negative embryos; **(ii) the presence of sHLA-G is not indicative of chromosome normality** [69,82] as no significant differences have been observed in sHLA-G expression between embryos diagnosed as chromosomally normal or abnormal. For this reason sHLA-G detection in conjunction with current morphological parameters to identify embryo implantation potential is needed.

In 2006 Ménézso et al. started a debate on the exact amount of sHLA-G produced by a single human embryo [88]. The authors have reported that human preimplantation embryo protein content is 45-50 ng with a consequent HLA-G release from 10 to 100% and above the total protein content of the embryo considering the levels of sHLA-G molecules in embryo supernatants claimed in the literature. The human embryo is able to produce high amounts of other proteins such as human chorionic gonadotropine (hCG) that can be detected in the mother's urine [89] suggesting a massive production at the fetomaternal interface. A possible explanation of this protein production could be found in the morphological and metabolic changes of preimplantation pluripotent embryonic cells:

**(I) the cleavage stages are characterized by** (i) a low metabolism, (ii) a high protein transduction rate and (iii) the necessity of exogenous pyruvate that are unusual features for any other mammalian somatic cell type [90];

**(II) matrix metalloproteinases**, the main proteinases facilitating the process of embryo implantation and uterus extracellular matrix remodeling and degradation [91], are present at all stages of embryo development from the one-cell to the blastocyst. It is known that metalloproteases enhance HLA-G shedding [92] suggesting the increased secretion of HLA-G by pre-implantation embryo as a result of metalloprotease activation;

**(III) day-3 embryos cultured in vitro for 48 hours are able to secrete protein patterns similar to those of day-5 uterine blastocysts** suggesting the *in vitro* culture is responsible for an accelerated embryo development and protein production [93].

These observations should be considered in the evaluation of the ability of embryonic cells to produce proteins as they have unique features and necessity in comparison with the other cell phenotypes. Their possibility to survive in the uterus is connected with their ability to escape the maternal immune system. Hence the importance, in the implantation process, to sustain an extensive HLA-G production.

Two studies [94,95] have failed to detect sHLA-G molecules in embryo culture supernatants underlining some discrepancies with other studies (**Table 4**). The authors that have observed positive sHLA-G embryo cultures have documented different percentages of positive supernatants (20-70%) and levels from 38 pg/ml to 1890 ng/ml. Warner et al. [96] have reviewed the literature present in PubMed at the end of 2007. They found differences in the specificity and concentrations of capture and detection antibodies, in the characteristics of positive and negative controls, in the time and temperature of incubation. The embryo cultures, the time of collection and other clinical parameters were also compared. They have concluded that the presence of significant technical discrepancies could explain these contrasting results.

Some of the differences that should be taken into consideration when comparing these different studies are: **(i) culture time; (ii) culture media; (iii) capture and detection antibodies; (iv) the standards (Table 4).**

The embryo culture time is in a range from 48 to 120 hrs post fertilization. This could explain at least in part the different levels of sHLA-G. The 48 - 72 hour culture period seems to be the best time points to detect sHLA-G in embryo supernatants and was selected in the majority of the studies. Where different culture time were used contrasting results as soluble HLA-G are predictable as secretion levels measured by ELISA may increase/decrease over time.

Culture media are also important for *in vitro* embryo growth [97] and can be divided accordingly to their composition in four groups: **(i) glucose and inorganic phosphate-free medium (P1, IVC-One); (ii) low-glucose medium (IVF, Sequential medium); (iii) glucose, gentamicin sulphate and protein-free medium (Human Tubal Fluid (HTF)); (iv) early cleavage medium (ECM).** The different composition of these culture media could have influenced sHLA-G production. Culture media play an important role in determining whether the embryo potential can be realized [98] leading to epigenetic changes in the embryonic genome [99] and influence gene expression [98,100,101,102]. Rinaudo P and Schultz R [101] have observed that the expression of 114 genes, including genes involved in protein synthesis, cell proliferation and transporter functions, are affected in embryo after *in vitro* culture. Optimizing a culture medium in terms of its ability to promote embryo growth [103] seems to avoid certain postnatal developmental and behavioural consequences and imply that minor variations in the culture media can lead to differences on the resulting embryos. For example human tubal fluid (HTF) and preimplantation stage one (P1) culture media differ in fertilization rate, embryo quality, implantation and pregnancy rates. Artini et al. [104] have demonstrated that embryo fertilization rate with HTF was 58.6% while with P1 62.5% ( $P = 0.003$ ), the HTF embryo quality was lower (15.4%) than P1 embryos (68.7%) ( $P = 0.002$ ) as the implantation rate (HTF embryos 6.8% versus P1 embryos 12.2%) ( $P = 0.02$ ) and the pregnancy rate (HTF embryos 17.1% versus P1 embryos 23.7%) ( $P = 0.02$ ). The use of

different culture media could have influenced the results obtained analysing sHLA-G production by early embryos.

The discrepancy between the different ELISA systems may be related to a lack of specificity associated with cross-reactivity among capture and detection antibodies. Some of the MoAbs that have been used in these studies have presented cross-reactivities: 4H84 MoAb has a cross-reactivity with HLA-Ia [105]; 5A6B MoAb seems to recognize the denaturated HLA-G heavy chain and to have an affinity also for other proteins; BFL.1 MoAb has a doubtful HLA-G specificity as it fails to react with HLA-G transfected cell lines [106]

The positive standards could be subdivided into: cell culture purified molecules and recombinant proteins. These molecules could present a different structural conformation with a different antibody affinity that could affect MoAb recognition.

**Table 4.** Soluble HLA-G expression by preimplantation human embryos.

Study	N. cultures	N. Women	N° positive cultures (%)	sHLA-G range (ng/ml)	Culture media	Hrs post fertilization	Capture Antibody	Detection Antibody	Standard
<b>Positive results</b>									
<b>Fuzzi B</b> Eur J Immunol (2002)	285	101	231 (26)	1.4 - 11	IVF	72	MEM-G9 (G1, G5)	W6/32 biotin	721.221G supernatant
<b>Roussev</b> Fertil Steril (2003)	>60	30	6 (20)	ND	P1	72	MEM-G9 (G1, G5)	W6/32 biotin	JEG3 supernatant
<b>Sher G</b> Reprod Biomed (2004)	1245	201	101 (64)	ND	P1	72	MEM-G9 (G1, G5)	W6/32 biotin	JEG3 supernatant
<b>Yie SM</b> Fertil Steril (2005)	386	137	270 (69.9)	10 - 1890	IVC One	72	4H84 (G1-G7)	3C/G4	Purified HLA-G from placenta
<b>Desai N</b> Reprod Biomed (2006)	712	83	309 (43)	3 - 10	HTF	72	MEM-G9 (G1, G5)	W6/32 biotin	Exbio standard
<b>Rebmann V</b> Human Immunol (2007)	588	313	117 (20)	0.038 – 5.628	IVF	48, 72, 96	MEM-G9 (G1, G5)	β2m	Purified sHLA-G
<b>Fisch JD</b> Fertil Steril (2007)	~2083	209	ND	ND	ECM	72	MEM-G9 (G1, G5)	W6/32 biotin	Human amniotic fluid
<b>Rizzo R</b> J Reprod Immunol (2007)	50	38	26 (52)	1.2 - 13.1	IVF	72	MEM-G9 (G1, G5)	β2m biotin	721.221G supernatant
<b>Lédée N</b> Am J Reprod Immunol (2007)	Day 2: 309 Day 3: 276	ND	Day 2: 71 (23) Day 3: 188 (68)	ND	ND	48-72	ND	ND	ND
<b>Shaikly VR</b> J Immunol (2008)	166	26	80 (50)	1.75 – 3.5	Sequential medium	48-72	MEM-G9 (G1, G5)	W6/32 biotin	Exbio standard
<b>Negative results</b>									
<b>van Lierop MJ</b> Mol Hum Reprod (2002)	15	ND	0	0	ND	48-120	G233 (G1, G5) 56B (G1, G4, G5) W6/32 (G1, G5)	56B biotin BFL.1 biotin 56B biotin	Recombinant HLA-G1
<b>Sageshima N</b> J Reprod Immunol (2007)	109	ND	0	0	ND	ND	MEM-G9 (G1, G5)	W6/32 biotin	721.221G supernatant



### **5.3. HLA-G and oocyte**

A growing knowledge of human embryos obtained during through ART has not been paralleled by a similar knowledge of human oocytes, despite it being widely recognized that embryogenesis is deeply affected by oocyte quality. The main reason for this is probably that the selection for ART is applied to embryos in order to choose the best among them to be transferred in uterus. This widely practiced embryo selection has prevented the need to acquire skills in oocyte selection. In some countries, new laws and rules on ART need to move towards oocyte selection and to identify valid tools to recognize the best oocytes to be used for fertilization [107]. Currently oocyte selection is performed by using morphological parameters, without a clear association with a positive pregnancy outcome [108]. The development of non-invasive methods for oocyte selection could be an important step in all the ART laboratories.

The oocyte quality is associated with early embryonic survival, the establishment and maintenance of pregnancy and fetal development. The quality and the developmental competence of an oocyte is acquired during the maturation process, during progressive differentiation throughout folliculogenesis. The ability of the oocyte to mature, be fertilized and to develop into a viable embryo starts with oocyte growth during the first steps of follicular development and goes on until the final oocyte capacitation. Ovarian cyclic activity induces some primordial follicles to grow, however, most of these follicles degenerate through atresia and in growing follicles, only a subset of oocytes are competent and able to support meiosis, fertilization and early embryo development to the blastocyst stage. Growing lines of evidence suggest that oocyte competence relies on the storage of messenger RNAs and proteins that will support early stages of embryo development, before full activation of embryonic genome. It is known that fertilized oocyte transcription is silenced in the early stages of embryo development and ~90% oocyte maternal mRNAs degrade in the 2 cell stage. The store of proteins in the fertilized oocyte is sufficient to support embryo development to the 8 cell stage until the activation of the embryonic genome [109]. The recent discovery of oocyte secreted factors and of their ability to regulate

surrounding somatic cells suggests a central role of the oocyte in the success of folliculogenesis [110].

The follicle activation is a fundamental event for the oocyte maturation and it is controlled by a fine tuning of inhibitory and stimulatory soluble factors. The follicular fluid represents the essential and specific microenvironment for the regulation of the ovary function and oocyte maturation [111] and a possible relationship has been proposed between specific follicular fluid components (sFas-sFas ligand system, TNF-alpha, Nitric oxide, Hyaluronan, Gelatinases) and ART outcome [112].

Rizzo R et al. [85] have analyzed sHLA-G molecules in the follicular fluids (FFs) and have found a significant correlation between sHLA-G presence in FFs and in the culture supernatants of the corresponding fertilized oocytes (**Figure 5**). Lédée et al. [86] and Shaikly et al. [69] have confirmed the presence of sHLA-G molecules in FFs in 96% and 47% respectively but they have failed to identify a correlation with early embryo sHLA-G production (**Table 5**). Several differences in embryo culture conditions and the technical procedures could explain the differences in the correlation results. The presence of sHLA-G in FFs is not a confirmation that it is important in oocyte maturation but the presence of HLA-G molecules in follicular fluids suggests the possible role of this antigen in the oocyte maturation process. Further studies are required to confirm the relationship between FFs and embryo sHLA-G production.

Rizzo et al. [85] and Shaikly et al. [69] have identified granulosa cells as producers of HLA-G molecules (**Figure 5**), while there are conflicting results on HLA-G protein expression by oocytes. Desoye et al. [66] have found no staining on three unfixed oocytes, while Roberts et al. [67] have found 2 of 11 to be positive and Jurisicova et al. [62,63] have shown a positive staining of 21 out of 33 oocytes. These findings have been confirmed by the presence of HLA-G mRNA in 17 of 21 pools of 5-8 unfertilized oocytes [62,63].

The possible implication of HLA-G molecules on oocyte maturation has been evaluated by Rizzo et al. [113] (**Figure 5**). They have analyzed the culture

supernatants of 152 oocytes matured *in vitro* for sHLA-G presence. The *in vitro* oocyte maturation procedure has allowed the analysis of sHLA-G production by the cumulus-oocyte complex (COC) without the influence of the *in vivo* maternal microenvironment. The cumulus oophorus is characterized by the granulosa cells which surround the mammalian oocyte. These cells create a structural pathway for cell-to-cell communication where cumulus cells provide several trophic factors to the preovulatory oocyte [114]. Several results indicate that the measurement of gene transcription levels in cumulus cells would reliably complement the morphological oocyte evaluation providing a useful tool for selecting oocytes with greater chances to be fertilized [115,116].

Rizzo et al. [113] have demonstrated that the COCs produce sHLA-G molecules during oocyte maturation process. The main point is that no sHLA-G molecules have been detected in the COC culture supernatants corresponding to immature COCs while the highest sHLA-G production has been shown in good grade COCs. Some matured COCs have failed to secrete sHLA-G, underlining that sHLA-G is only one of the factors implicated in this process. Further studies are necessary to confirm the possible role of HLA-G molecules in oocyte maturation and to evaluate if HLA-G could be a marker of oocyte quality.

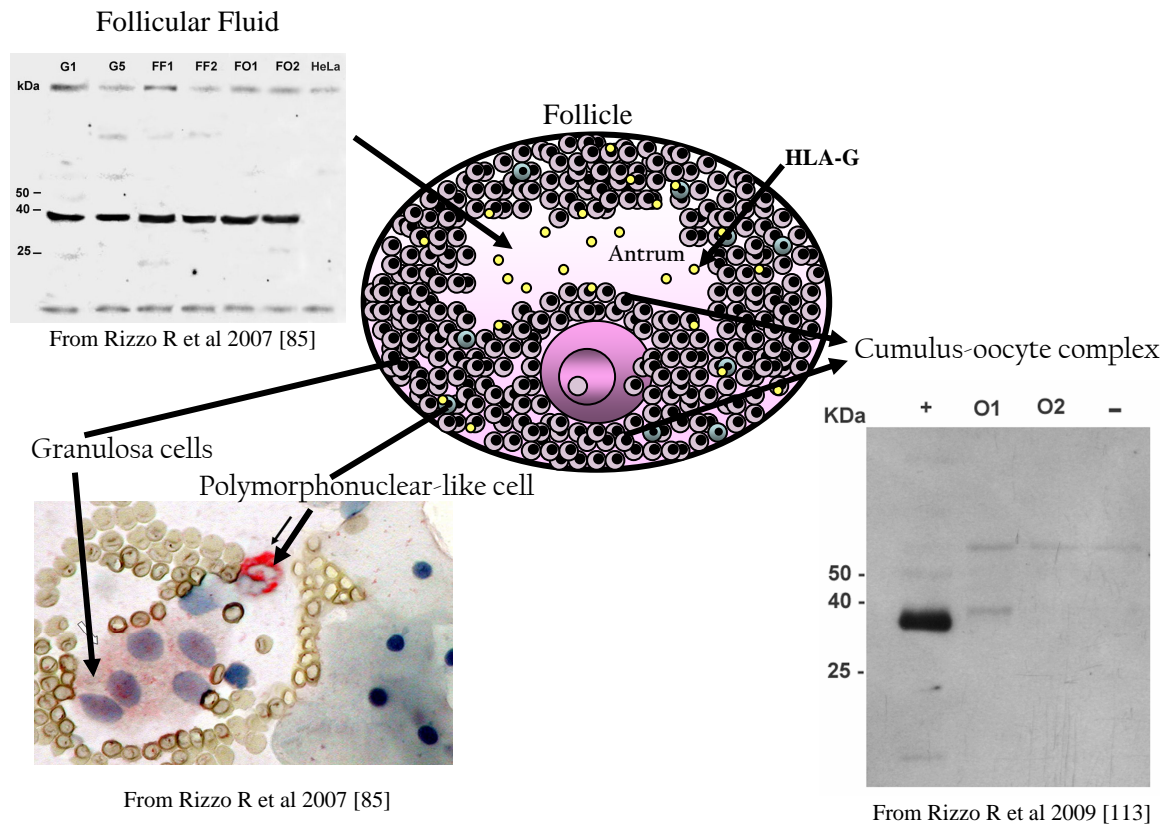

**Figure 5. HLA-G expression in mature follicle.** HLA-G molecules are present in follicular fluid as evidenced by Western Blot analysis with MEM-G9 moAb (G1, G5: positive controls; FF1, FF2: follicular fluid; FO1, FO2: fertilized oocyte; HeLa: negative control) [85], in granulosa cells and polymorphonuclear cells as demonstrated by immunocytochemistry with MEM-G9 moAb [85] and in cumulus-oocyte complex as shown by Western Blot analysis with MEM-G9 moAb (+: positive control, -: negative control; O1, O2: cumulus-oocyte complex) [113].

**Table 5.** Soluble HLA-G expression in follicular fluids (FFs) and by the corresponding preimplantation human embryos.

Study	N. FFs	N. Women	N° positive embryo cultures (%)	sHLA-G range in embryo (ng/ml)	N° positive FFs (%)	sHLA-G range in FFs (ng/ml)	Culture media	Hrs post fertilization	Capture Antibody	Detection Antibody	Standard
<b>Rizzo R</b> J Reprod Immunol (2007)	50	38	26 (52)	1.2 - 13.1	19 (38)	12.8-162.0	IVF	72	MEM-G9 (G1, G5)	β2m biotin	721.221G supernatant
<b>Lédée N</b> Am J Reprod Immunol (2007)	117	ND	Day 2: 20 (23) Day 3: 58 (68)	ND	82 (96)	ND	ND	48 - 72	ND	ND	ND
<b>Shaikly</b> J Immunol (2008)	60	12	13 (21)	1.75 – 3.5	29 (47)	1.75-4.0	IVF	72	MEM-G9 (G1, G5)	W6/32 biotin	Exbio standard

## **6. Expected HLA-G impact in ART**

Currently, different approaches are used to select oocytes and embryos for ART procedures, but they do not assure a significant association with the pregnancy outcome.

Several studies have analyzed the possible implication of HLA-G molecules in the selection of embryos and oocytes for ART. Further analysis and novel approaches are necessary to overcome the contrasting results obtained by different researchers [117]. The possible use of HLA-G antigens as a marker for oocyte and embryo selection is auspicious as it could firstly increase the chances of success with ART, secondly allow the selection of the best oocyte/embryo to transfer so reducing the number of transferred embryos and hence the incidence of multiple pregnancies.

## **7. Expert commentary**

Further research is needed to evaluate the potential of sHLA-G as a marker of oocyte/embryo competency and to provide definitive proof that soluble HLA-G molecules are secreted by early embryos. Clearly the analysis of HLA-G molecules has to be improved given the contrasting results obtained in trophoblasts cells [59]. Unfortunately, it is not currently possible to measure HLA-G mRNA and membrane-bound protein in the same oocyte/embryo, which would help to clarify these issues. The possible approach could be:

**(i) a multicentre study where different laboratories could compare their results on the same samples.**

Several technical workshops have been organized in 2000, 2003 and 2004 to validate tools and protocols for HLA-G analysis [118,119] and laboratories are trying to agree standardization, in accordance with the Essen workshop in 2004 and the EMBIC Workshop on sHLA-G and Embryo Implantation in Oxford (June 2008).

**(ii) the use of different techniques to confirm both positive and negative results.**

Several researchers are trying to develop new tools to analyze HLA-G molecules. Rizzo et al. [85] have proposed a cytofluorimetric assay to detect rapidly sHLA-G

molecules; recently Rebmann et al. [83] have established a rapid detection assay based on Luminex technology, allowing sHLA-G quantification in sample volumes of only 10µl within 1.5 hours. These techniques could be an important improvement in order to increase the specificity and sensitivity of sHLA-G detection assays.

Further studies need to answer to the following questions: **(i)** What are the functions of sHLA-G during oocyte maturation and embryo implantation?, **(ii)** Why do some preimplantation embryos secrete sHLA-G and others not?, **(iii)** Where do sHLA-G molecules in FFs come from?

## **8. Five-year view**

Much remains to be learned about the expression, regulation and functions of HLA-G gene products at the junction of fetal and maternal tissues. Cellular sources remain unclear and target cells are still not well defined.

How the semi-inflammatory conditions of the maternal–fetal interface might influence HLA class Ib gene expression is unknown. The functions of these antigens at the interface, during the embryo implantation and oocyte maturation remain to be precisely defined.

Despite these uncertainties, much progress has been made. It now seems likely that HLA-G is not simply an evolutionary remnant but is, instead, a major player in the establishment of an appropriate immunologic state for semiallogeneic pregnancy.

Despite the considerable progress in HLA-G detection there are some problems in its analysis in oocyte/embryo culture supernatants.

Nowadays it is still mandatory to evaluate oocyte/embryo morphological parameters as research should confirm the role of HLA-G molecules in oocyte/embryo development.

The value of sHLA-G molecules as a marker of oocyte/embryo competency is extremely important as, in contrast with other techniques such as Pre-Implantation Genetic Diagnosis (PGD), this test is performed in a completely non-invasive way by

removing a small amount of the culture media surrounding two- and three-day-old embryos, and testing for sHLA-G.

The sHLA-G molecule is a research response to the need of a rational basis to select few and possibly single competent oocyte/embryo at a time, while maintaining optimal ART success rates.

Discovery of additional molecular markers [120] of oocyte/embryo competency and health will improve the potentiality of these non-invasive methodologies with wide possibilities for research and therapeutic application.

The future of ART will be to combine morphologic evaluations with a biochemical assessment of molecules that represent a marker of oocyte/embryo competency. The expected impact will be to increase the pregnancy rates that will be possible when the success rates will achieve a high quality value using these approaches and the detection of these molecules will be no more questionable. The ART laboratories could use morphologic parameters and biochemical markers for single embryo transfer, reducing the risk of multiple pregnancies.

However further research is needed to identify the real oocyte/embryo competence markers. HLA-G molecules could be one of them but it is mandatory to improve a standardized detection in order to obtain comparable results prior to use HLA-G as a oocyte/embryo selection marker.

### **Key issues**

- Currently it is difficult to determine the more appropriate oocyte/embryo for transfer in ART protocols
- sHLA-G detection in oocyte/embryo culture supernatants could be a non-invasive method to determine oocyte/embryo quality
- Embryos with sHLA-G production are more likely to result in a successful implantation
- sHLA-G detection in embryo culture supernatants should be further analyzed to identify the possible role as marker for embryo selection



- Possible correlation between sHLA-G detection in follicular fluids and in the corresponding fertilized oocyte
- sHLA-G detection in follicular fluids should be further analyzed to identify the possible role as marker for oocyte selection
- Possible correlation between sHLA-G detection in mature COCs
- sHLA-G detection in COC supernatants should be further analyzed to identify the possible role as marker for oocyte maturation

## Acknowledgment

Thanks to Prof. Olavio Baricordi, Dr Marina Stignani, Dr Loredana Melchiorri and Dr. Amanda Neville for writing assistance.

## References

1. Steptoe PC. Clinical aspects of pregnancies established with cleaving embryos grown in vitro. *BR. J. Obstet. Gynecol.* 87, 757-768 (1980).
2. Schultz RM. The science of ART. *Science* 296, 2188-2190 (2002).
3. Sutcliffe AG. IVF children: The first generation. *Parthenon publishing: New York* (2002).
4. Redman CW, McMichael AJ, Stirrat GM, Sunderland CA, Ting A. Class 1 major histocompatibility complex antigens on human extra-villous trophoblast. *Immunology* 52(3), 457-68 (1984).
5. Geraghty DE, Koller BH, Orr HT. A human major histocompatibility complex class I gene that encodes a protein with a shortened cytoplasmic segment. *Proc Natl Acad Sci U S A* 84(24), 9145-9149 (1987).

6. Warner CM, Panda P, Almquist CD et al. Preferential survival of mice expressing the Qa-2 antigen. *J. Reprod. Fertil.* 99(1), 145-147 (1993).
7. Comiskey M, Goldstein CY, De Fazio SR, Mammolenti M, Newmark JA, Warner CM. Evidence that HLA-G is the functional homolog of mouse Qa-2, the Ped gene product. *Hum. Immunol.* 64(11), 999-1004 (2003).
8. Rajagopalan S, Bryceson YT, Kuppusamy SP, et al. Activation of NK cells by an endocytosed receptor for soluble HLA-G. *PLoS Biol.* 4, e9 (2006).
9. Brown D, Trowsdale J, Allen R. The LILR family: modulators of innate and adaptive immune pathways in health and disease. *Tissue Antigens* 64, 215e25 (2004).
10. Carosella ED, Moreau P, Lemaoult J, Rouas-Freiss N. HLA-G: from biology to clinical benefits. *Trends Immunol.* 29(3), 125-132 (2008).
11. Hviid TV, Rizzo R, Melchiorri L, Stignani M, Baricordi OR. Polymorphism in the 5' upstream regulatory and 3' untranslated regions of the HLA-G gene in relation to soluble HLA-G and IL-10 expression. *Hum. Immunol.* 67, 53–62 (2006).
12. Hviid TV, Hylenius S, Rørbye C, Nielsen LG. HLA-G allelic variants are associated with differences in the HLA-G mRNA isoform profile and HLA-G mRNA levels. *Immunogenetics* 55, 63–79 (2003).
13. Rizzo R, Hviid TV, Stignani M, et al. The HLA-G genotype is associated with IL-10 levels in activated PBMCs. *Immunogenetics* 57(3-4), 172-181 (2005).
14. Hviid TV, Rizzo R, Christiansen OB, Melchiorri L, Lindhard A, Baricordi OR. HLA-G and IL-10 in serum in relation to HLA-G genotype and polymorphisms. *Immunogenetics* 56, 135–141 (2004).
15. Chen XY, Yan WH, Lin A, Xu HH, Zhang JG, Wang XX. The 14 bp deletion polymorphisms in HLA-G gene play an important role in the expression of soluble HLA-G in plasma. *Tissue Antigens* 72, 335-341 (2008).
16. Rousseau P, Le Discorde M, Mouillot G, Marcou C, Carosella ED, Moreau P. The 14 bp deletion-insertion polymorphism in the 3' UT region of the HLA-G

- gene influences HLA-G mRNA stability. *Hum. Immunol.* 64(11), 1005-1010 (2003).
17. Solier C, Mallet V, Lenfant F, Bertrand A, Huchenoq A, Le Bouteiller P. HLA-G unique promoter region: functional implications. *Immunogenetics* 53, 617-625 (2001).
  18. Lefebvre S, Berrih-Aknin S, Adrian F, et al. A specific interferon (IFN)-stimulated response element of the distal HLA-G promoter binds IFN-regulatory factor 1 and mediates enhancement of this nonclassical class I gene by IFN-beta. *J. Biol. Chem.* 276(9), 6133-6139 (2001).
  19. Gobin SJ, Biesta P, de Steenwinkel JEM, Datema G, van den Elsen P. HLA-G transactivation by cAMP-response element-binding protein (CREB). *J. Biol. Chemistry* 277(42), 39525-31 (2002).
  20. Moreau P, Mouillot G, Rousseau P, Marcou C, Dausset J, Carosella ED. HLA-G gene repression is reversed by demethylation. *Proc Natl Acad Sci USA* 100, 1191-1196 (2003).
  21. Mouillot G, Marcou C, Rousseau P, Rouas-Freiss N, Carosella ED, Moreau P. HLA-G gene activation in tumor cells involves cisacting epigenetic changes. *Int. J. Cancer* 113, 928-936 (2005).
  22. Hviid TVF, Møller C, Sørensen S, Morling N. Co-dominant Expression of the HLA-G Gene and Various Forms of Alternatively Spliced HLA-G mRNA in Human First Trimester Trophoblast. *Human Immunol.* 59(2), 87-98 (1998).
  23. Copeman J, Han RN, Caniggia I, McMaster M, Fisher SJ, Cross JC. Posttranscriptional regulation of human leukocyte antigen G during human extravillous cytotrophoblast differentiation. *Biol. Reprod.* 62(6), 1543-1550 (2000).
  24. Carosella ED, Moreau P, Le Maoult J, Le Discorde M, Dausset J, Rouas-Freiss N. HLA-G molecules: from maternal-fetal tolerance to tissue acceptance. *Adv. Immunol.* 81, 199-252 (2003).

25. Dong Y, Lieskovska J, Kedrin D, Porcelli S, Mandelboim O, Bushkin Y. Soluble nonclassical HLA generated by the metalloproteinase pathway. *Hum. Immunol.* 64, 802-810 (2003).
26. Comiskey M, Domino KE, Warner CM. HLA-G is found in lipid rafts and can act as a signaling molecule. *Hum. Immunol.* 68(1), 1-11 (2007).
27. Lin A, Yan WH, Xu HH, et al. HLA-G expression in human ovarian carcinoma counteracts NK cell function. *Ann. Oncol.* 18(11), 1804-9 (2007).
28. Contini P, Ghio M, Poggi A, et al. Soluble HLA-A,-B,-C and -G molecules induce apoptosis in T and NK CD8 cells and inhibit cytotoxic T cell activity through CD8 ligation. *Eur. J. Immunol.* 33, 125–34 (2003).
29. Lila N, Rouas-Freiss N, Dausset J, Carpentier A, Carosella ED. Soluble HLA-G protein secreted by allo-specific CD4 T cells suppresses the allo-proliferative response: a CD4 T cell regulatory mechanism. *Proc. Natl. Acad. Sci. USA* 98, 12150–12155 (2001).
30. Ristich V, Liang S, Zhang W, Wu J, Horuzsko A. Tolerization of dendritic cells by HLA-G. *Eur. J. Immunol.* 35, 1133–42 (2005).
31. Le Rond S, Azéma C, Krawice-Radanne I, et al. Evidence to support the role of HLA-G5 in allograft acceptance through induction of immunosuppressive/regulatory T cells. *J. Immunol.* 176, 3266–3276 (2006).
32. Fons P, Chabot S, Cartwright JE, et al. Soluble HLA-G1 inhibits angiogenesis through an apoptotic pathway and by direct binding to CD160 receptor expressed by endothelial cells. *Blood* 108, 2608–2615 (2006).
33. Shiroishi M, Kuroki K, Rasubala L, et al. Structural basis for recognition of the nonclassical MHC molecule HLA-G by the leukocyte Ig-like receptor B2 (LILRB2/LIR2/ILT4/CD85d) *Proc. Natl. Acad. Sci. USA.* 103(44), 16412-16417 (2006).
34. Yan WH, Fan LA. Residues Met76 and Gln79 in HLA-G alpha1 domain involve in KIR2DL4 recognition. *Cell Res.* 15(3), 176-182 (2005).

35. Gonen-Gross T, Achdout H, Gazit R, et al., Complexes of HLA-G protein on the cell surface are important for leukocyte Ig-like receptor-1 function. *J. Immunol.* 171, 1343–1351 (2003).
36. Gonen-Gross T, Achdout H, Arnon TI, et al., The CD85J/leukocyte inhibitory receptor-1 distinguishes between conformed and beta 2-microglobulin-free HLA-G molecules. *J. Immunol.* 175, 4866–4874 (2005).
37. Apps R, Gardner L, Sharkey AM, Holmes N, Moffett A. A homodimeric complex of HLA-G on normal trophoblast cells modulates antigen-presenting cells via LILRB1. *Eur. J. Immunol.* 37(7), 1924-1937 (2007).
38. LeMaoult J, Caumartin J, Daouya M, et al. Immune regulation by pretenders: cell-to-cell transfers of HLA-G make effector T cells act as regulatory cells. *Blood* 109(5), 2040-2048 (2007).
39. Baricordi OR, Stignani M, Melchiorri L, Rizzo R. HLA-G and inflammatory diseases *Inflamm. Allergy Drug Targets* 7(2), 67-74 (2008).
40. Hunt JS. Stranger in a strange land. *Immunol. Rev.* 213, 36-47 (2006).
41. Medawar PB. Some immunological and endocrinological problems raised by the evolution of viviparity in vertebrates. *Symp. Soc. Exp. Biol.* 44, 320-338 (1953).
42. Piccinni MP. T cells in normal pregnancy and recurrent pregnancy loss. *Reprod. Biomed. Online* 13(6), 840-844 (2006).
43. Steinborn A, Varkonyi T, Scharf A, Bahlmann F, Klee A, Sohn C. Early detection of decreased soluble HLA-G levels in the maternal circulation predicts the occurrence of preeclampsia and intrauterine growth retardation during further course of pregnancy. *Am. J. Reprod Immunol.* 57(4), 277-286 (2007).
44. Hackmon R, Hallak M, Krup M, et al. HLA-G antigen and parturition: maternal serum, fetal serum and amniotic fluid levels during pregnancy. *Fetal Diagn. Ther.* 19(5), 404-409 (2004).

45. Yie SM, Taylor RN, Librach C. Low plasma HLA-G protein concentrations in early gestation indicate the development of preeclampsia later in pregnancy. *Am. J. Obstet. Gynecol.* 193, 204-208 (2005).
46. Rizzo R, Stignani M, Amoudruz P, et al. Allergic women have reduced sHLA-G plasma levels at delivery. Submitted to *Am. J. Immunol.* (2008).
47. Borzychowski AM, Sargent IL, Redman CW. Inflammation and pre-eclampsia. *Semin. Fetal Neonatal Med.* 11, 309– 316 (2006).
48. Hackmon R, Koifman A, Hyodo H, Glickman H, Sheiner E, Geraghty DE. Reduced third-trimester levels of soluble human leukocyte antigen G protein in severe preeclampsia. *Am. J. Obstet. Gynecol.* 197(3), 255.e1-5 (2007).
49. Pfeiffer KA, Rebmann V, Pässler M, et al. Soluble histocompatibility antigen levels in early pregnancy after IVF. *Hum Immunol.* 61, 559-564 (2000).
50. Hanna J, Goldman-Wohl D, Hamani Y, et al. Decidual NK cells regulate key developmental processes at the human fetal-maternal interface. *Nat. Med.* 12, 1065–1074 (2006).
51. van der Meer A, Lukassen HGM, van Lierop MJC, et al. Membrane-bound HLA-G activates proliferation and interferon-gamma production by uterine natural killer cells *Mol. Hum. Reprod.* 10, 189–195 (2004).
52. Ellis SA, Sargent IL, Redman CW, McMichael AJ. Evidence for a novel HLA antigen found on human extravillous trophoblast and a choriocarcinoma cell line. *Immunology* 59, 595e601 (1986).
53. Hunt JS, Morales PJ, Pace JL, Fazleabas AT, Langat DK. A Commentary on Gestational Programming and Functions of HLA-G in Pregnancy. *Placenta* 28(Supplement A, Trophoblast Research Vol. 21), S57eS63 (2007).
54. Yang Y, Chu W, Geraghty DE, Hunt JS. Expression of HLA-G in human mononuclear phagocytes and selective induction by IFN-gamma. *J. Immunol.* 156(11), 4224-4231 (1996).
55. Blaschitz A, Lenfant F, Mallet V, et al. Endothelial cells in chorionic fetal vessels of first trimester placenta express HLA-G. *Eur. J. Immunol.* 27(12), 3380-3388 (1997).

56. Ishitani A, Sageshima N, Lee N, et al. Protein expression and peptide binding suggest unique and interacting functional roles for HLA-E, F, and G in maternal-placental immune recognition. *J. Immunol.* 171, 1376-1384 (2003).
57. Morales PJ, Pace JL, Platt JS, et al. Placental cell expression of HLA-G2 isoforms is limited to the invasive trophoblast phenotype. *J. Immunol.* 171, 6215-6224 (2003).
58. LeMaoult J, Rouas-Freiss N, Carosella ED. HLA-G5 expression by trophoblast cells: the facts. *Mol. Hum. Reprod.* 11(10), 719-722 (2005).
59. Blaschitz A, Juch H, Volz A, et al. The soluble pool of HLA-G produced by human trophoblasts does not include detectable levels of the intron 4-containing HLA-G5 and HLA-G6 isoforms. *Mol. Hum. Reprod.* 11, 699-710 (2005).
60. Goldman-Wohl D, Ariel I, Greenfield C, et al. Lack of human leukocyte antigen-G expression in extravillous trophoblasts is associated with pre-eclampsia. *Mol. Hum. Reprod.* 6, 88-95 (2000).
61. Yie SM, Li LH, Li YM, Librach C. HLA-G protein concentrations in maternal serum and placental tissue are decreased in preeclampsia. *Am. J. Obstet. Gynecol.* 191, 525-529 (2004).
62. Jurisicova A, Casper RF, MacLusky NJ, Librach CL. Embryonic human leukocyte antigen-G expression: possible implications for human preimplantation development. *Fertil. Steril.* 65, 997-1002 (1996a).
63. Jurisicova A, Casper RF, MacLusky NJ, Mills GB, Librach CL. HLA-G expression during preimplantation human embryo development. *Proc. Natl. Acad. Sci. USA* 93, 161-165 (1996b).
64. Yao YQ, Barlow DH, Sargent IL. Differential expression of alternatively spliced transcripts of HLA-G in human preimplantation embryos and inner cell masses. *J. Immunol.* 175(12), 8379-8385 (2005).
65. Hunt JS, McIntire RH, Petroff MG. Immunobiology of human pregnancy. In: *Knobil and Neill's physiology of reproduction.* (Volume 2). Neill JD (Ed.), Elsevier/Academic Press St. Louis, MO, 2759-2785 (2006).

66. Desoye G, Dohr GA, Motter W, et al. Lack of HLA class I and class II antigens on human preimplantation embryos. *J. Immunol.* 140, 4157-4159 (1988).
67. Roberts JM, Taylor CT, Melling GC, Kingsland CR, Johnson PM. Expression of the CD46 antigen, and absence of class I MHC antigen, on the human oocyte and preimplantation blastocyst. *Immunology* 75, 202-205 (1992).
68. Hiby SE, King A, Sharkey A, Loke YW. Molecular studies of trophoblast HLA-G: polymorphism, isoforms, imprinting and expression in preimplantation embryo. *Tissue Antigens* 53, 1-13 (1999).
69. Shaikly VR, Morrison IE, Taranissi M, Noble CV et al. Analysis of HLA-G in maternal plasma, follicular fluid, and preimplantation embryos reveal an asymmetric pattern of expression. *J. Immunol.* 180(6), 4330-4337 (2008).
70. Menicucci A, Noci I, Fuzzi B et al. Non-classic sHLA class I in human oocyte culture medium. *Human Immunol.* 60(11), 1054-1057 (1999).
71. Fuzzi B, Rizzo R, Criscuoli L, et al. HLA-G expression in early embryos is a fundamental prerequisite for the obtainment of pregnancy. *Eur. J. Immunol.* 32, 311-315 (2002).
72. Rizzo R, Baricordi OR. HLA-G expression and regulation in early embryos. *Am. J. Reprod. Immunol.* 56(1), 17 (2006).
73. Rizzo R, Melchiorri L, Stignani M, Baricordi OR. HLA-G expression is a fundamental prerequisite to pregnancy. *Human Immunol.* 68(4), 244-250 (2007).
74. Roussev RG, Keskindepe L, Coulam CB. Soluble HLA-G (sHLA-G) in human embryo culture media: a useful marker for assessing embryo quality and implantation potential for IVF. *Fertil. Steril.* 80, S12-13 (2003).
75. Sher G, Keskindepe L, Nouriani M, et al. Expression of sHLA-G in supernatants of individually cultured 46-h embryos: a potentially valuable indicator of 'embryo competency' and IVF outcome. *Reprod. Biomed. Online* 9(1), 74-78 (2004).



76. Criscuoli L, Rizzo R, Fuzzi B, et al. Lacking of HLA-G expression in early embryos is not related to germinal defects or impairment in IL-10 embryos production. *Gynecological Endocrinology* 20(5), 264-269 (2005).
77. Noci I, Fuzzi B, Rizzo R, et al. Embryonic soluble HLA-G as a marker of developmental potential in embryos. *Hum. Reprod.* 20(1), 138-146 (2005).
78. Sher G, Keskinetepe L, Batzofin J, et al. Influence of early ICSI-derived embryo sHLA-G expression on pregnancy and implantation rates: a prospective study. *Hum. Reprod.* 20(5), 1359-1363 (2005a).
79. Sher G, Keskinetepe L, Fisch JD, et al. Soluble human leukocyte antigen G expression in phase I culture media at 46 hours after fertilization predicts pregnancy and implantation from day 3 embryo transfer. *Fertil. Steril.* 83(5), 1410-1413 (2005b).
80. Yie SM, Balakier H, Motamedi G, et al. Secretion of human leukocyte antigen-G by human embryos is associated with a higher in vitro fertilization pregnancy rate. *Fertil. Steril.* 83(1), 30-36 (2005).
81. Wang Q, Zhuang GL, Zhou CQ, et al. Expression of soluble human leukocyte antigen G and its relationship to embryo development. *Zhonghua Fu Chan Ke Za Zhi* 40(2), 112-115 (2005).
82. Desai N, Filipovits J, Goldfarb J. Secretion of soluble HLA-G by day 3 human embryos associated with higher pregnancy and implantation rates: assay of culture media using a new ELISA kit. *Reprod. Biomed. Online.* 13(2), 272-277 (2006).
83. Rebmann V, Switala M, Eue I, et al. Rapid evaluation of soluble HLA-G levels in supernatants of in vitro fertilized embryos. *Human Immunol.* 68(4), 251-258 (2007).
84. Fisch JD, Keskinetepe L, Ginsburg M, et al. Graduated Embryo Score and soluble human leukocyte antigen-G expression improve assisted reproductive technology outcomes and suggest a basis for elective single-embryo transfer. *Fertil. Steril.* 87(4), 757-763 (2007).

85. Rizzo R, Fuzzi B, Stignani M, et al. Soluble HLA-G molecules in follicular fluid: a tool for oocyte selection in IVF? *J. Reprod. Immunol.* 74(1-2), 133-42 (2007).
86. Lédée N, Thonon F, Perrier d’hauterive S, et al. Significance of soluble HLA-G detection in follicular fluids and embryo supernatants in IVF/ICSI cycles. *Am. J. Reprod. Immunol.* 57, MS7–MS5 (2007).
87. Vercammen MJ, Verloes A, Van de Velde H, Haentjens P. Accuracy of soluble human leukocyte antigen-G for predicting pregnancy among women undergoing infertility treatment: meta-analysis. *Hum. Reprod. Update* 14(3), 209-218 (2008).
88. Ménézo Y, Elder K, Viville S. Soluble HLA-G release by the human embryo: an interesting artefact? *Reprod. Biomed. Online* 13, 763-764 (2006).
89. Sargent I, Swales A, Ledee N, Kozma N, Tabiasco J, Le Bouteiller P. sHLA-G production by human IVF embryos: can it be measured reliably? *J. Reprod. Immunol.* 75(2), 128-132 (2007).
90. Devreker F, Englert Y. In vitro development and metabolism of the human embryo up to the blastocyst stage. *Eur. J. Obstet. Gynecol. Reprod. Biol.* 92(1), 51-56 (2000).
91. Chen L, Nakai M, Belton RJ Jr, Nowak RA. Expression of extracellular matrix metalloproteinase inducer and matrix metalloproteinases during mouse embryonic development. *Reproduction* 133(2), 405-414 (2007).
92. Díaz-Lagares A, Alegre E, Lemaoult J, Carosella ED, González A. Nitric oxide produces HLA-G nitration and induces metalloprotease-dependent shedding creating a tolerogenic milieu. *Immunology* In press (2008).
93. Nieder GL. Analysis of proteins secreted by mouse embryos developing in vivo and in vitro. *J. Exp. Zool.* 252(2), 134–142 (1989).
94. van Lierop MJ, Wijnands F, Loke YW, et al. Detection of HLA-G by a specific sandwich ELISA using monoclonal antibodies G233 and 56B. *Mol. Human Reprod.* 8(8), 776-784 (2002).

95. Sageshima N, Shobu T, Awai K, et al. Soluble HLA-G is absent from human embryo cultures: A reassessment of sHLA-G detection methods. *J. Reprod. Immunol.* 75(1), 11-22. (2007).
96. Warner CM, Lampton PW, Newmark JA, Cohen J. Symposium: innovative techniques in human embryo viability assessment. Soluble human leukocyte antigen-G and pregnancy success. *Reprod. Biomed. Online* 17(4), 470-485 (2008).
97. Ménézo Y, Chouteau J, Guyader-Joly C, Veiga A. Sequential media: why and how? *Contracept. Fertil. Sex.* 27(6), 449-451 (1999).
98. Lonergan P, Rizos D, Gutierrez-Adan A, Fair T, Boland M. Oocyte and embryo quality: effect of origin, culture conditions and gene expression patterns. *Reprod. Dom. Anim.* 38, 259–267 (2003).
99. Mann M, Lee S, Doherty A, Verona R, Nolen L, Schultz R, Bartolomei M. Selective loss of imprinting in the placenta following preimplantation development in culture. *Development* 131, 3727–3735 (2004).
100. Niemann H, Wrenzycki C. Alterations of expression of developmentally important genes in preimplantation bovine embryos by in vitro culture conditions: implications for subsequent development. *Theriogenology* 53, 21–34 (2000).
101. Rinaudo P, Schultz R. Effects of embryo culture on global pattern of gene expression in preimplantation mouse embryos. *Reproduction* 128, 301–311 (2004).
102. Behr B, Wang H. Effects of culture conditions on IVF outcome. *Eur. J. Obstet. Gynecol. Reprod. Biol.* 115(Suppl), S72–S76 (2004).
103. Ecker D, Stein P, Xu Z, et al. Long-term effects of culture of preimplantation mouse embryos on behavior. *Proc. Natl. Acad. Sci. USA* 101, 1595–1600 (2004).
104. Artini PG, Valentino V, Cela V, Cristello F, Vitè A, Genazzani AR. A randomized control comparison study of culture media (HTF versus P1) for

- human in vitro fertilization. *Eur. J. Obstet. Gynecol. Reprod. Biol.* 116(2), 196-200 (2004).
105. Poláková K, Kuba D, Russ G. The 4H84 monoclonal antibody detecting beta2m free nonclassical HLA-G molecules also binds to free heavy chains of classical HLA class I antigens present on activated lymphocytes. *Hum. Immunol.* 65(2), 157-162 (2004).
  106. Blaschitz A, Hutter H, Leitner V, et al. Reaction patterns of monoclonal antibodies to HLA-G in human tissues and on cell lines: a comparative study. *Hum. Immunol.* 61(11), 1074-1085 (2000).
  107. Fineschi V, Neri M, Turillazzi E. The new Italian law on assisted reproduction technology. *J. Med. Ethics* 31, 536–539 (2005).
  108. Coticchio, G, Sereni E, Serrao L, Mazzone S, Iadarola I, Borini A. What criteria for the definition of oocyte quality? *Ann. N. Y. Acad. Sci.* 1034, 132–144 (2004).
  109. Nothias JY, Majumder S, Kaneko KJ, DePamphilis ML. Regulation of gene expression at the beginning of mammalian development. *J. Biol. Chem.* 270, 22077-22080 (1995).
  110. Mermillod P, Dalbiès-Tran R, Uzbekova S, et al. Factors affecting oocyte quality: who is driving the follicle? *Reprod. Domest. Anim.* 43(Suppl 2), 393-400 (2008).
  111. Mendoza C, Ruiz-Requena E, Ortega E, et al. Follicular fluid markers of oocyte developmental potential. *Hum. Reprod.* 17 (4), 1017-1022 (2002).
  112. Baka S, Malamitsi-Puchner A. Novel follicular fluid factors influencing oocyte developmental potential in IVF: a review. *Reprod. Biomed. Online* 12(4), 500-506 (2006).
  113. Rizzo R, Dal Canto MB, Stignani M, et al. Production of sHLA-G molecules by “in vitro” matured cumulus-oocyte complex. Submitted to *J. Reprod. Immunol.* (2008).

114. Gilchrist RB, Ritter LJ, Armstrong DT. Oocyte-somatic cell interactions during follicle development in mammals. *Anim. Reprod. Sci.* 82-83, 431-446 (2004).
115. Feuerstein P, Cadoret V, Dalbies-Tran R, Guerif F, Bidault R, Royere D. Gene expression in human cumulus cells: one approach to oocyte competence. *Hum. Reprod.* 22, 3069-3077 (2007).
116. Cillo F, Brevini TA, Antonini S, Paffoni A, Ragni G, Gandolfi F. Association between human oocyte developmental competence and expression levels of some cumulus genes. *Reproduction* 134, 645-650 (2007).
117. Apps R, Gardner L, Moffett A. A critical look at HLA-G. *Trends Immunol.* 29, 313-321 (2008).
118. Paul P, Rouas-Freiss N, Moreau P, et al. HLA-G, -E, -F preworkshop: tools and protocols for analysis of non-classical class I genes transcription and protein expression. *Hum. Immunol.* 61(11), 1177-1195 (2000).
119. Menier C, Saez B, Horejsi V, et al. Characterization of monoclonal antibodies recognizing HLA-G or HLA-E: new tools to analyze the expression of nonclassical HLA class I molecules. *Hum. Immunol.* 64(3), 315-326 (2003).
120. Borgatti M, Rizzo R, Canto MB, et al. Release of sICAM-1 in oocytes and in vitro fertilized human embryos. *PLoS ONE* 3(12), e3970 (2008).

## **Abstract**

### **Background**

Assisted reproduction technique (ART) pregnancy rates have not changed in recent years and an increased risk of twins, triplets or higher order pregnancies leads to a perinatal mortality and morbidity. Studies have therefore involved the identification of non-invasive methods to determine the oocyte/embryo quality allowing fewer embryos to be transferred while maintaining or improving pregnancy rates.

In order to increase the chance of a successful pregnancy, the most viable embryos must be transferred but current knowledge of suitable biochemical markers that could predict the viability of embryos is extremely limited. The selection of embryos to be transferred is conducted using morphological aspects, cleavage speed and development appearance. This embryo scoring system could help in selecting the best embryo for transfer but it has limited ability to predict the implantation potential of individual embryos. The clinical challenge is to establish a marker of embryo competency that could increase the pregnancy rate following ART and reduce the number of multiple pregnancies.

Successful implantation in the human is dependent on the early embryo ability to avoid the maternal immune system. The fetus is considered a semi-allograft but, in normal pregnancies, it is not rejected by the maternal immune system. The presence of a complex signalling system, with molecules passing from the conceptus to the mother throughout pregnancy, is appealing and embryo suppressor factors responsible for early implantation have been proposed. One of the key protective mechanisms is thought to be the expression of non classical HLA class I HLA-G molecules by trophoblasts. Due to its importance in reproductive immunology it has been considered a possible marker for oocyte/embryo selection.

The *HLA-G* gene is located at the telomeric part of the 6p21-3 chromosomal region, near the *HLA-A* locus. It exhibits the typical structure of a classical HLA class I gene with a similar exon/intron organization. The HLA-G antigen has some characteristics that differentiate it from classical HLA class I antigens. The HLA-G molecule has a restricted tissue distribution, being expressed in physiological conditions by

cytotrophoblasts and thymus. The allelic polymorphism is limited to 36 alleles. The *HLA-G* gene is characterized by a 14 base pair insertion/deletion polymorphism (rs16375) in exon 8 in the 3' untranslated region (UTR) that is associated with mRNA stability and HLA-G protein expression. The allele with an insertion of 14 bp has been associated with lower levels of HLA-G expression than the allele with the 14 bp deleted. Seven different HLA-G transcriptional isoforms, derived from mRNA splicing, have been described. Four of these encode membrane-bound products (HLA-G1, -G2, -G3, -G4), the other three soluble proteins (HLA-G5, -G6, -G7). It is well known that the biological functions of the classical HLA-class I and class II molecules are related to the complex mechanism of antigen recognition. The high polymorphism of the HLA structures represent a guarantee for the development of an efficient response against different viral and bacterial antigens whilst the elevated number of alleles is responsible for the allogeneic response resulting in the rejection of transplanted organs. HLA class Ia and HLA class II genes are totally unexpressed in cytotrophoblast cells preventing the consequential development of a semiallogenic response of the maternal CD8 positive T cells. However, the absence of HLA-Ia molecules would enhance the natural killer (NK) mediated cell cytotoxicity that is normally inhibited by the presence on target cells of the classical HLA-I determinants. The modulation of HLA-C and the nearly monomorphic HLA-G molecules by invasive cytotrophoblasts prevents the allogeneic response and maintain a tolerogenic microenvironment. Membrane-bound HLA-G1 and soluble HLA-G (HLA-G5 and sHLA-G1) molecules exert immunosuppressive effects: **(i)** inhibit the cytotoxic activity of CD8 positive T lymphocytes (CTL) and NK cells, **(ii)** induce the apoptosis of NK and activated cytotoxic T cells, **(iii)** inhibit the allogeneic CD4 positive T-cell proliferation and interfere with naïve CD4 positive T-cell priming, **(iv)** inhibit antigen presenting cell and B lymphocyte differentiation, **(v)** induce regulatory T cells. sHLA-G affects angiogenesis interacting with endothelial cells and induces resting NK cells to produce chemokines and cytokines [1]. The functions of HLA-G molecules are due to their ability to act as a ligand for different receptors expressed by immune cells. HLA-G interacts with NK receptor KIR2DL4

and leukocyte inhibitory receptors (LILRs) / immunoglobulin-like transcripts (ILT) as LILRB1 (LIR-1/ILT2/CD85j), which is highly expressed on T and B lymphocytes and with LILRB2 (LIR-2/ILT4/CD85d), present mainly in monocytes/macrophages.

### **Aim**

This thesis reports on several studies of the HLA-G molecule and its implication in pregnancy and embryo implantation.

### **Methods and Results**

The analysis of the soluble HLA-G (sHLA-G) levels in lipopolysaccharide (LPS)-activated peripheral blood mononuclear cell (PBMC) cultures from healthy subjects has revealed no differences between the three HLA-G insertion/deletion 14 bp genotypes (+14/+14 bp, -14/+14 bp, +14/+14 bp), while higher concentrations of interleukin (IL)-10, the main up-modulator of HLA-G production, have been observed in the +14/+14bp LPS-PBMC cultures [2]. Our data support the hypothesis of a feed-back loop mechanism between HLA-G and IL-10 molecules, which sustains their production. The -14/-14 bp and -14/+14 bp HLA-G samples with a -477 G/G single nucleotide polymorphism (SNP) genotype in the 5' upstream regulatory region (5'URR) of the *HLA-G* gene have presented a higher IL-10 concentration in LPS-PBMC cultures. These observations could indicate that the -477 SNP might have an independent impact on IL-10 concentration and that the differences are not only a consequence of *linkage disequilibrium* between the G -477 SNP polymorphism and the -14 bp 3'UTR polymorphism. -477 SNP polymorphism is located very close to a putative heat shock element (HSE) and could influence the binding of the heat shock factor 1 (HSF1) leading to differences in IL-10 and sHLA-G expression.

The levels of sHLA-G are increased in the plasma samples of pregnant women during the first trimester in comparison to non-pregnant women. On the contrary sHLA-G plasma levels decrease during the third trimester while it has an impressive boost at delivery [3]. We have analyzed sHLA-G and IL-10 levels in the plasma samples of 43 women (15 non-allergic, 28 allergic) during third trimester, at delivery and 2 years after pregnancy. A significant increase in sHLA-G and IL-10 levels has



been documented at delivery regardless of the allergic status, however, allergic women have shown lower sHLA-G concentrations in comparison with non-allergic women. The reduced sHLA-G levels have not been caused by deficient IL-10 production, as allergic and non-allergic women presented equal amounts at all three time points investigated. This indicates that other factors involved in sHLA-G production and/or regulation differ between these two groups of women. It is possible that the Th2 cytokine microenvironment present in an allergic individual differently influences the sHLA-G secretion. Two years after pregnancy, the two groups have presented equal levels as the allergic women seem to experience a prime during pregnancy that is still evident two years after pregnancy, suggesting the presence of immunological changes imposed by pregnancy and still evident two years after labour. Our data have demonstrated that sHLA-G1 molecules are the most frequent isoform in plasma (75-80%) in both allergic and non-allergic women during labour. As sHLA-G1 molecules are mainly originated by metalloproteinase (MMP)-dependent shedding at post-translational level of the membrane antigens, it could be hypothesized that sHLA-G1 could derive from the placenta disruption during labour that is characterized by an increase in MMP-9 amounts.

Several data have suggested an important role for HLA-G molecules in the survival of human embryos. HLA-G expression has been documented not only on trophoblast cells but also in preimplantation human embryos. Jurisicova et al. [4] have shown HLA-G heavy chain specific mRNA in about 40% of the 148 embryos tested. HLA-G proteins at 2-cell stage and an increased embryo cleavage rate when compared to the embryos without HLA-G transcripts were detected. These results propose a variable expression of HLA-G during the critical period of preimplantation embryonic development. In order to have an *in vitro* and non-invasive system to analyze embryo behaviour towards sHLA-G production, an *in vitro* fertilization protocol was used, where the oocytes are fertilized *in vitro* and the embryos are transferred to the woman 2-3 days after fertilization. This allowed the analysis of the embryo culture supernatants for sHLA-G presence by a specific immunoenzymatic assay. In 2002 the first *in vivo* confirmation of the pivotal role of HLA-G molecules

in embryo implantation was presented [5]. The presence of sHLA-G molecules in 285 supernatants from cultures containing one to four embryos obtained from ART has been analyzed. Although no clinical differences have been observed between the women, positive embryo implantation occurred only in women with sHLA-G molecules in embryo culture supernatants ( $p= 2.56 \times 10^{-3}$ , Fisher's exact p test). This is the first observation made in humans to prove the importance of HLA-G expression in embryo implantation. In 2004 the analysis of sHLA-G molecules in supernatants from 318 single embryo cultures was presented [6]. We have confirmed a significant relationship between the secretion of these molecules by an early embryo and a higher implantation rate ( $p= 0.045$ , Mann-Whitney U test). These data propose the sHLA-G analysis in embryo supernatants as a useful marker, together with morphological characterization, for the selection of embryos to be transferred. Since 2002 up to six thousand supernatants from single ART procedure embryos have been analyzed for sHLA-G presence. Discrepancies in the embryo culture protocol and the sHLA-G detection systems have not yet allowed the importance of sHLA-G as an embryo quality marker to be confirmed and studies are still needed to standardize the procedures to sustain the data obtained [7,8].

No hypotheses have yet been advanced on the absence of HLA-G expression in a percentage of early embryos obtained by ART. The presence of germinal defects or an impaired IL-10 secretion can be hypothesized. The presence of sHLA-G in the supernatants of single embryo cultures from couples admitted to a second fertilization procedure has been analyzed. These couples have previously shown a complete absence of sHLA-G in the first cycle embryo supernatants (0/31) [9]. The results obtained in the second *in vitro* fertilization cycle have shown some embryo supernatants positive for HLA-G (14/40), suggesting that the previous lack of antigen modulation is independent of germinal defects. The levels of IL-10 in the same embryo culture supernatants have been also investigated. No associations have been observed between the presence of IL-10, the production and levels of sHLA-G and pregnancy outcome. These results indicate that the lack of sHLA-G production

in some early embryos is not related to germinal defects or IL-10 impairment and suggest a gestational programming of sHLA-G secretion.

Several ethical and legislative problems are increasing the necessity to reduce also the number of fertilized oocytes. Nowadays the oocyte selection is mainly performed by intra and extracytoplasmic morphological characteristics, but no data documents a clear association between the morphology and implantation outcome. The oocyte ability to mature, be fertilized and to develop into a viable embryo starts with oocyte growth during the first steps of follicular development and goes on until the final “oocyte capacitation” that seems to rely on the storage of messenger RNAs and proteins that will support early stages of embryo development, before full activation of embryonic genome. It is known that in the early developmental stage of the fertilized oocytes the transcription is silenced and the activation of the human embryonic genome starts between the 4- and 8-cell stages, approximately 70 hours after fertilization. Follicular fluid (FF) represents a specific microenvironment for oocyte maturation and a possible relationship has been proposed between specific FF components and ART outcome. 50 FFs were analyzed for sHLA-G molecule presence [10] and detectable sHLA-G molecules were observed in 31.2% FFs. To investigate the possible functional significance of sHLA-G molecules in FFs, we have related the sHLA-G in FFs and in the corresponding 4-8-cell early embryos. This analysis has shown a significant relationship between sHLA-G presence in FFs and in the corresponding embryo culture supernatants ( $p= 1.3 \times 10^{-6}$ ; Fisher exact p test). These results could suggest the analysis of sHLA-G in FFs as a reliable and non-invasive tool for oocytes selection to obtain embryos with an elevated ability to modulate HLA-G expression and consequently a higher implantation rate. Granulosa cells and the polymorphonuclear population have been identified as sHLA-G producers but because of ethical problems it was not possible to characterize the oocyte.

In order to confirm that sHLA-G is involved in oocyte maturation, 152 *in vitro* matured oocytes were analyzed of which culture supernatants could be characterized for sHLA-G presence without the influence of the maternal

microenvironment [11]. Our results have demonstrated that the cumulus-oocyte complex (COC), characterized by the surrounding granulosa cells and the oocyte, produces sHLA-G. The sHLA-G molecules were present in 19% of mature COC culture supernatants. On the contrary no sHLA-G molecules have been detected in the culture supernatants from immature COCs ( $p= 8.4 \times 10^{-5}$ ; Fisher exact p test). These results show, for the first time, the ability of mature COCs to produce sHLA-G antigens that seem to be a marker for oocyte maturation.

### **Conclusions**

Further research on HLA-G and pregnancy to evaluate the possible correlation between the oocyte and the corresponding embryo sHLA-G production and to confirm the value of sHLA-G as a marker of oocyte/embryo competency is required. Work is also necessary to improve standardization of sHLA-G detection in order to obtain comparable results prior to use HLA-G as an oocyte/embryo selection marker. The sHLA-G molecules is a research response to the need for a rational basis to select few and possibly a single competent oocyte/embryo each time, while maintaining optimal ART success rates. The future of ART foresees the combination of morphologic evaluations with a biochemical assessment of molecules that represent a marker of embryo competency.

Future identification of additional molecular markers of oocyte/embryo competency and health can improve these non-invasive methods and their research and therapeutic potential. The culture supernatants of 39 immature and 73 mature COCs and the corresponding preimplantation embryos for the presence of proteins involved in inflammation, including several cytokines, chemokines (IL-1 $\beta$ , IL-1 $\alpha$ , IL-2, IL-4, IL-5, IL-6, IL-7, IL-8, IL-9, IL-10, IL-12 (P70), IL-13, IL-15, IL-17, Basic FGF, Eotaxin, G-CSF, GM-CSF, IFN- $\gamma$ , IP-10, MCP-1 (MCAF), MIP-1 $\alpha$ , MIP-1 $\beta$ , PDGF-BB, RANTES, TNF- $\alpha$ , VEGF) and soluble intercellular adhesion molecule 1 (sICAM-1) have been analyzed [12]. The proteins present in the supernatants were sICAM-1 and IL-1 $\alpha$ , however, only sICAM-1 was expressed at high levels. The sICAM-1 release is very high in immature COCs, decreases in mature COCs ( $p < 0.0001$ , Student t Test) and become even lower in preimplantation embryos ( $p <$

0.0001, Student t Test). No significant differences have been observed in sICAM-1 levels between immature oocytes with different morphological characteristics. On the contrary, the high grade mature COCs have presented the lower sICAM levels. sICAM-1 seems to have a clear tendency to decrease from immature to mature COCs and to fertilized embryos and it could be a possible biochemical marker for COC maturation and grading.

In the future ART laboratories may be able to use morphologic parameters and these non-invasive biochemical markers for single embryo transfer, so reducing the risk of multiple gestation and increasing the pregnancy rate.

## References

1. Baricordi OR, Stignani M, Melchiorri L, Rizzo R. HLA-G and inflammatory diseases *Inflamm. Allergy Drug Targets* 7(2), 67-74 (2008).
2. Hviid TV, Rizzo R, Melchiorri L, Stignani M, Baricordi OR. Polymorphism in the 5' upstream regulatory and 3' untranslated regions of the HLA-G gene in relation to soluble HLA-G and IL-10 expression. *Hum. Immunol.* 67, 53–62 (2006).
3. Rizzo R, Stignani M, Amoudruz P, et al. Allergic women have reduced sHLA-G plasma levels at delivery. Submitted to *Am. J. Immunol.* (2008).
4. Jurisicova A, Casper RF, MacLusky NJ, Librach CL. Embryonic human leukocyte antigen-G expression: possible implications for human preimplantation development. *Fertil. Steril.* 65, 997-1002 (1996).
5. Fuzzi B, Rizzo R, Criscuoli L, et al. HLA-G expression in early embryos is a fundamental prerequisite for the obtainment of pregnancy. *Eur. J. Immunol.* 32, 311-315 (2002).
6. Noci I, Fuzzi B, Rizzo R, et al. Embryonic soluble HLA-G as a marker of developmental potential in embryos. *Hum. Reprod.* 20(1), 138-146 (2005).
7. Rizzo R, Baricordi OR. HLA-G expression and regulation in early embryos. *Am. J. Reprod. Immunol.* 56(1), 17 (2006).

8. Rizzo R, Melchiorri L, Stignani M, Baricordi OR. HLA-G expression is a fundamental prerequisite to pregnancy. *Human Immunol.* 68(4), 244-250 (2007).
9. Criscuoli L, Rizzo R, Fuzzi B, et al. Lacking of HLA-G expression in early embryos is not related to germinal defects or impairment in IL-10 embryos production. *Gynecological Endocrinology* 20(5), 264-269 (2005).
10. Rizzo R, Fuzzi B, Stignani M, et al. Soluble HLA-G molecules in follicular fluid: a tool for oocyte selection in IVF? *J. Reprod. Immunol.* 74(1-2), 133-42 (2007).
11. Rizzo R, Dal Canto MB, Stignani M, et al. Production of sHLA-G molecules by “in vitro” matured cumulus-oocyte complex. Submitted to *J. Reprod. Immunol.* (2008).
12. Borgatti M, Rizzo R, Canto MB, et al. Release of sICAM-1 in oocytes and in vitro fertilized human embryos. *PLoS ONE* 3(12), e3970 (2008).

## **Riassunto (Abstract in Italian)**

### **Introduzione**

Nonostante gli importanti sviluppi della procedura di riproduzione medicalmente assistita (ART), la percentuale di gravidanze ottenute non ha subito modifiche negli ultimi anni ed il rischio di parti gemellari e multipli con una conseguente mortalità e morbidity perinatale è rimasto invariato. Come conseguenza, numerosi studi sono attualmente coinvolti nell'identificazione di metodi non invasivi per determinare la qualità dell'ocita/embrione al fine di consentire il trasferimento di un numero ridotto di embrioni, mantenendo o incrementando la percentuale di gravidanze ottenute.

Al fine di aumentare la probabilità di ottenere un esito positivo della gravidanza, sarebbe necessario trasferire l'embrione maggiormente vitale. Attualmente, la conoscenza di marcatori biochimici, che possano essere utilizzati per predire la vitalità embrionale, è estremamente limitata. La selezione degli embrioni da trasferire è effettuata sulla base di aspetti morfologici, di sviluppo e di velocità di clivaggio, con una limitata capacità nel predire il potenziale di impianto del singolo embrione. Il traguardo della clinica è di stabilire un marcatore di competenza embrionale che possa incrementare la percentuale di gravidanze ottenute in seguito a procedura ART riducendo il numero di gravidanze multiple.

La capacità dell'embrione di evitare il sistema immunitario materno è alla base dell'impianto nell'utero materno. Il feto è considerato un trapianto semi-allogeneico che durante una normale gravidanza non viene rigettato dal sistema immunitario materno. La presenza di un complesso sistema di segnali tra il feto e la madre supporta l'esistenza di fattori soppressori embrionali responsabili dell'impianto. Uno dei meccanismi chiave della protezione sembra essere l'espressione di molecole non classiche HLA (Antigene leucocitario umano) di classe I HLA-G da parte dei trofoblasti. Considerando la sua importanza nell'ambito della riproduzione si è ipotizzato un suo possibile ruolo come marcatore per la selezione oocitaria/embrionale.

Il gene *HLA-G* é localizzato nella porzione telomerica della regione cromosomica 6p21-3, adiacente al locus *HLA-A*. Presenta un'organizzazione di esoni/introni simile a quella dei geni classici HLA di classe I. L'antigene HLA-G è caratterizzato da alcune peculiarità che lo differenziano dagli antigeni classici HLA di classe I. Le molecole HLA-G hanno una ristretta distribuzione tissutale, con espressione da parte di citotrofoblasti e cellule timiche in condizioni fisiologiche. Il polimorfismo allelico è limitato a 36 alleli. Il gene *HLA-G* é caratterizzato da un polimorfismo di inserzione/delezione di 14 paia di basi (rs16375) a livello dell'esone 8 nella regione 3' non tradotta (UTR) che è associato alla stabilità del mRNA ed all'espressione proteica di HLA-G. L'allele con l'inserzione di 14 bp presenta livelli di espressione di HLA-G inferiori rispetto all'allele con le 14 bp delete. Sono state descritte sette isoforme trascrizionali dovute a splicing alternativo del mRNA. Quattro di queste sono molecole associate alla membrana (HLA-G1, -G2, -G3, -G4), le altre tre sono proteine solubili (HLA-G5, -G6, -G7). E' noto come le funzioni biologiche delle molecole classiche HLA di classe I e di classe II siano associate al complesso meccanismo di riconoscimento antigenico. In questo contesto l'alto polimorfismo delle strutture HLA garantisce lo sviluppo di un'efficiente risposta contro diversi antigeni virali e batterici. D'altra parte, l'elevato numero di alleli è responsabile dello sviluppo di una risposta allogenica risultante nel rigetto degli organi trapiantati. I geni HLA di classe Ia e di classe II non sono espressi dai citotrofoblasti prevenendo il conseguente sviluppo di una risposta semiallogenica da parte delle cellule materne T CD8 positive. Al contrario, l'assenza di molecole HLA-Ia attiverebbe la citotossicità mediate dalle cellule natural killer (NK), normalmente inibite dalla presenza di determinanti classici HLA-I sulla superficie delle cellule bersaglio. La modulazione di molecole HLA-C e HLA-G da parte dei citotrofoblasti invasivi previene la risposta allogenica e mantiene un microambiente tollerogenico. Le molecole HLA-G1 di membrana e solubili HLA-G (HLA-G5 e sHLA-G1) esercitano effetti immunosoppressivi: **(i)** inibiscono l'attività citotossica dei linfociti T CD8 positivi (CTL) e delle cellule NK, **(ii)** inducono l'apoptosi di cellule NK e T citotossiche attivate, **(iii)** inibiscono la proliferazione allogenica dei linfociti T CD4



positivi ed interferiscono con la maturazione delle cellule T naïve CD4 positive, (iv) inibiscono le cellule presentanti l'antigene ed il differenziamento dei linfociti B, (v) inducono le cellule T regolatorie. Inoltre, sHLA-G interviene nell'angiogenesi attraverso le cellule endoteliali e la produzione chemochine e citochine da parte delle cellule NK [1]. Le funzioni delle molecole HLA-G risiedono nella loro capacità di agire da ligandi di recettori espressi dalle cellule del sistema immunitario. HLA-G interagisce con il recettore delle cellule NK KIR2DL4 e con i recettori inibitori dei leucociti (LILRs) / trascritti immunoglobulin-like (ILT) come LILRB1 (LIR-1/ILT2/CD85j), altamente espresso dai linfociti T e B e LILRB2 (LIR-2/ILT4/CD85d), presente prevalentemente nei monociti/macrofagi.

### **Scopo**

Questa tesi riporta diversi studi relativi alla molecola HLA-G e alla sua implicazione nella gravidanza e nell'impianto embrionale.

### **Metodi e Risultati**

L'analisi dei livelli di HLA-G solubile (sHLA-G) in colture di cellule mononucleate da sangue periferico (PBMCs), derivate da soggetti sani ed attivate con lipopolisaccaride (LPS), ha evidenziato l'assenza di differenze tra i tre genotipi HLA-G 14 bp (+14/+14 bp, -14/+14 bp, +14/+14 bp), mentre sono state osservate concentrazioni più elevate di interleuchina (IL)-10, il maggiore stimolatore della produzione di HLA-G, nelle colture PBMC-LPS-attivate con genotipo +14/+14 bp [2]. I nostri dati supportano l'ipotesi di un meccanismo *feed-back loop* tra le molecole HLA-G ed IL-10, che sostiene la loro produzione. I campioni -14/-14 bp e -14/+14 bp con un genotipo -477 G/G polimorfismo a singolo nucleotide (SNP) nella regione regolatoria 5' *upstream* (5'URR) del gene *HLA-G*, hanno presentato concentrazioni più elevate di IL-10 nelle colture PBMC-LPS-attivate. Queste osservazioni potrebbero indicare come il -477 SNP possa avere un effetto indipendente sulle concentrazioni di IL-10 e le differenze non siano solo causate da *linkage disequilibrium* tra il polimorfismo G -477 SNP ed il polimorfismo -14 bp 3'UTR. Infatti il polimorfismo -477 SNP è localizzato in vicinanza di un putativo

*heat shock element* (HSE) e potrebbe influenzare il legame del *heat shock factor 1* (HSF1) portando a differenze nell'espressione di IL-10 e sHLA-G.

I livelli di sHLA-G sono aumentati nel plasma di donne gravide durante il primo trimestre rispetto a donne non gravide. Al contrario i livelli di sHLA-G nel plasma diminuiscono durante il terzo trimestre mentre subiscono un incremento al parto [3]. Abbiamo analizzato i livelli di sHLA-G e IL-10 nel plasma di 43 donne (15 non-allergiche, 28 allergiche) durante il terzo trimestre, al parto e due anni dopo la gravidanza. E' stato documentato un incremento significativo nei livelli di sHLA-G e IL-10 al parto indipendentemente dallo stato allergico, anche se le donne allergiche hanno presentato livelli di sHLA-G piú bassi rispetto alle donne non-allergiche. I livelli ridotti di sHLA-G non sono stati causati da una ridotta produzione di IL-10, in quanto sia le donne allergiche che quelle non-allergiche hanno mostrato livelli simili in tutti e tre i punti analizzati. Questo indica la presenza di altri fattori implicati nella produzione e/o regolazione di sHLA-G che differiscono tra i due gruppi. E' possibile che il microambiente citochinico Th2 presente negli individui allergici influenzi in modo diverso la secrezione di sHLA-G. I due gruppi hanno presentato livelli uguali due anni dopo la gravidanza, come se le donne allergiche avessero subito un'attivazione durante la gravidanza, ancora visibile dopo due anni, suggerendo la presenza di cambiamenti immunologici. I nostri dati hanno dimostrato che le molecole sHLA-G1 sono l'isoforma piú frequente nel plasma (75-80%) sia delle donne allergiche che non-allergiche durante il parto. Considerando la derivazione delle molecole sHLA-G1 da taglio proteolitico degli antigeni di membrana dipendente da metalloproteinasi (MMP), può essere ipotizzato che sHLA-G1 derivi dalla distruzione della placenta durante il parto, evento caratterizzato da un incremento di MMP-9.

Diversi dati hanno suggerito un ruolo importante per le molecole HLA-G nella sopravvivenza degli embrioni umani. L'espressione di HLA-G è stata documentata non solo a livello dei trofoblasti ma anche negli embrioni umani preimpianto. Jurisicova et al. [4] hanno evidenziato la presenza di mRNA HLA-G specifico in circa il 40% dei 148 embrioni testati. Inoltre gli autori hanno rilevato molecole HLA-

G negli embrioni allo stadio di due cellule ed un incremento della velocità di clivaggio embrionale rispetto agli embrioni senza trascritto HLA-G. Questi dati propongono un'espressione variabile di HLA-G durante il periodo di sviluppo embrionale preimpianto. Al fine di avere un sistema *in vitro* e non invasivo per analizzare la secrezione di sHLA-G da parte dell'embrione, è stato utilizzato il protocollo di fecondazione *in vitro*, in cui gli oociti vengono fecondati *in vitro* e gli embrioni trasferiti 2-3 giorni dopo la fecondazione. Questo sistema ha permesso di valutare i soprannati di colture embrionali per la presenza di sHLA-G utilizzando un'analisi immunoenzimatica specifica. Nel 2002 è stata presentata la prima conferma *in vitro* del ruolo delle molecole HLA-G nell'impianto embrionale [5]. È stata analizzata la presenza di molecole sHLA-G in 285 soprannati di colture contenenti da uno a quattro embrioni ottenuti con ART. Nonostante non siano state osservate differenze cliniche, solo le donne con molecole sHLA-G nei soprannati delle colture embrionali hanno presentato impianto embrionale positivo ( $p = 2.56 \times 10^{-3}$ , Fisher's exact p test). Questa è stata la prima osservazione effettuata nell'uomo che provi l'importanza dell'espressione di HLA-G nell'impianto embrionale.

Nel 2004 è stata condotta l'analisi delle molecole sHLA-G in 318 soprannati da colture singole embrionali [6]. Abbiamo confermato la relazione significativa tra la secrezione di queste molecole da parte dell'embrione ed un'incrementata probabilità di impianto ( $p = 0.045$ , Mann-Whitney U test). Questi dati propongono l'analisi di sHLA-G nei soprannati embrionali come marcatore, unitamente alla caratterizzazione morfologica, per la selezione degli embrioni da trasferire. Dal 2002 ad oggi sono stati analizzati più di sei mila soprannati di colture embrionali singole ottenute da procedure ART per la presenza di sHLA-G. Le discrepanze nei protocolli di coltura degli embrioni e nei sistemi di analisi di sHLA-G non hanno ancora confermato l'importanza di sHLA-G come marcatore di qualità embrionale e numerosi studi saranno necessari per standardizzare le procedure e confermare i risultati ottenuti [7,8].

Non è stata ancora spiegata l'assenza di molecole sHLA-G in una percentuale di embrioni ottenuti con ART. È possibile ipotizzare la presenza di difetti germinali o

una produzione diminuita di IL-10. E' stata analizzata la presenza di sHLA-G nei sopranatanti di colture di singolo embrione di coppie ammesse ad un secondo ciclo di fertilizzazione; queste coppie non avevano presentato colture embrionali positive per sHLA-G nel primo ciclo (0/31). I risultati ottenuti nel secondo ciclo ART hanno mostrato alcuni sopranatanti embrionali positivi per sHLA-G (14/40), suggerendo che la precedente mancanza di antigene fosse indipendente da difetti germinali. Sono stati analizzati i livelli di IL-10 nelle stesse colture embrionali. Non è stata osservata alcuna associazione tra la presenza di IL-10, la produzione ed i livelli di sHLA-G ed il risultato della gravidanza. Questi dati indicano come la mancanza di produzione sHLA-G in alcuni sopranatanti embrionali non sia dovuta a difetti germinali o diminuita produzione di IL-10 e suggeriscono la presenza di un programma gestazionale nella secrezione di sHLA-G.

Numerosi problemi etici e legislativi stanno aumentando la necessità di ridurre il numero di oociti fertilizzati. Attualmente, la selezione degli oociti è svolta utilizzando caratteristiche morfologiche intra ed extracitoplasmatiche, senza avere una chiara associazione tra la morfologia e l'esito dell'impianto. La capacità dell'oocita di maturare, di essere fertilizzato e di svilupparsi in un embrione vitale inizia con la crescita oocitaria durante le prime fasi dello sviluppo follicolare e continua fino alla "capacitazione oocitaria" che sembra associarsi alla riserva di RNA messaggeri e proteine che supporterebbero le prime fasi di sviluppo embrionale, prima della completa attivazione del genoma embrionale. E' noto come nelle prime fasi di sviluppo degli oociti fertilizzati la trascrizione sia silenziata e l'attivazione del genoma embrionale inizi allo stadio di 4-8 cellule, approssimativamente 70 ore dopo la fertilizzazione. Il fluido follicolare (FF) rappresenta il microambiente specifico per la maturazione oocitaria ed è stata proposta una possibile relazione tra i componenti del FF e l'esito del ART. Sono stati analizzati 50 FF per la presenza di molecole sHLA-G [9] e le molecole sHLA-G sono state rilevate nel 31.2% dei FF. Per valutare il possibile ruolo funzionale degli antigeni sHLA-G nei FF, abbiamo correlato i livelli di sHLA-G nei FF con le concentrazioni rilevate nei corrispondenti embrioni allo stadio di 4-8 cellule. Questa

analisi ha mostrato una relazione significativa tra la presenza di sHLA-G nei FF e nei corrispondenti soprannatanti di colture embrionali ( $p= 1.3 \times 10^{-6}$ ; Fisher exact p test). Questi risultati potrebbero suggerire l'analisi di sHLA-G nei FF come metodica affidabile e non invasiva per la selezione degli oociti, al fine di ottenere embrioni con un'elevata capacità di modulare l'espressione di HLA-G e conseguentemente con una maggiore probabilità di impianto. Abbiamo identificato le cellule della granulosa e la popolazione polimorfonucleata come produttori di sHLA-G ma non abbiamo potuto caratterizzare gli oociti per problemi etici.

Al fine di confermare il coinvolgimento di sHLA-G nella maturazione oocitaria, sono stati analizzati 152 oociti maturati in vitro, i cui soprannatanti possono essere caratterizzati facilmente per la presenza di sHLA-G senza subire l'influenza del microambiente materno. I nostri risultati hanno dimostrato come il complesso oocita-cumulo (COC), caratterizzato dalle cellule della granulosa strettamente associate e dall'oocita, producano sHLA-G. La presenza di sHLA-G è stata rilevata nel 19% dei soprannatanti di colture di COC maturi. Al contrario non sono state rilevate molecole sHLA-G nei soprannatanti di colture di COC immaturi ( $p= 8.4 \times 10^{-5}$ ; Fisher exact p test). Questi risultati mostrano, per la prima volta, la capacità dei COC maturi di produrre sHLA-G che potrebbe essere un marcatore di maturazione oocitaria.

### **Conclusioni**

Le prospettive della ricerca relativa a HLA-G e gravidanza potrebbero riguardare la valutazione della possibile correlazione tra la produzione di sHLA-G da parte del COC e dell'embrione corrispondente e confermare il valore di sHLA-G come marcatore di competenza oocitaria/embrionale. La ricerca deve migliorare e standardizzare la rilevazione di sHLA-G al fine di ottenere risultati comparabili prima dell'utilizzo di HLA-G come marcatore per la selezione oocitaria/embrionale.

Le molecole sHLA-G sono una delle risposte della ricerca alla necessità di una base razionale per la selezione di pochi o possibilmente un singolo oocita/embrione competente, mantenendo ottimale la percentuale di successi del ART. Il futuro del

ART sarà di combinare valutazioni morfologiche con l'analisi biochimica di molecole marcatori di competenza oocitaria/embrionale.

L'identificazione di nuovi marcatori di competenza e vitalità oocitaria/embrionale potrà migliorare la potenzialità di queste metodologie non-invasive con implicazioni nella ricerca e nella clinica. Sono stati analizzati i soprannatanti di colture di 39 COC immaturi, di 73 COC maturi e dei corrispondenti embrioni preimpianto per la presenza di proteine coinvolte nell'infiammazione, includendo citochine, chemochine (IL-1 $\beta$ , IL-1 $\alpha$ , IL-2, IL-4, IL-5, IL-6, IL-7, IL-8, IL-9, IL-10, IL-12 (P70), IL-13, IL-15, IL-17, Basic FGF, Eotaxin, G-CSF, GM-CSF, IFN- $\gamma$ , IP-10, MCP-1 (MCAF), MIP-1 $\alpha$ , MIP-1 $\beta$ , PDGF-BB, RANTES, TNF- $\alpha$ , VEGF) e la molecola solubile intercellular adhesion molecule 1 (sICAM-1) [12]. Le uniche proteine rilevate nei soprannatanti sono state sICAM-1 e IL-1 $\alpha$ , con sICAM-1 espressa a livelli più elevati. Il rilascio di sICAM-1 è molto elevato nei COC immaturi, diminuisce nei COC maturi ( $p < 0.0001$ , Student t Test) e raggiunge valori ancora inferiori negli embrioni preimpianto ( $p < 0.0001$ , Student t Test). Non sono state osservate differenze significative tra i livelli di sICAM-1 tra COC immaturi con caratteristiche morfologiche diverse. Al contrario, i COC maturi con alto grado hanno presentato i livelli di sICAM più bassi. sICAM-1 sembra avere una chiara tendenza a diminuire dal COC immaturo a quello maturo sino all'embrione e potrebbe essere un marcatore biochimico di maturazione e grado del COC.

La prospettiva per i laboratori di ART potrebbe essere l'utilizzo di parametri morfologici e di marcatori biochimici non invasivi per la selezione di oociti ed embrioni, riducendo il rischio di gravidanze multiple ed aumentando la probabilità di gravidanza.

## **Bibliografia**

1. Baricordi OR, Stignani M, Melchiorri L, Rizzo R. HLA-G and inflammatory diseases *Inflamm. Allergy Drug Targets* 7(2), 67-74 (2008).

2. Hviid TV, Rizzo R, Melchiorri L, Stignani M, Baricordi OR. Polymorphism in the 5' upstream regulatory and 3' untranslated regions of the HLA-G gene in relation to soluble HLA-G and IL-10 expression. *Hum. Immunol.* 67, 53–62 (2006).
3. Rizzo R, Stignani M, Amoudruz P, et al. Allergic women have reduced sHLA-G plasma levels at delivery. Submitted to *Am. J. Immunol.* (2008).
4. Jurisicova A, Casper RF, MacLusky NJ, Librach CL. Embryonic human leukocyte antigen-G expression: possible implications for human preimplantation development. *Fertil. Steril.* 65, 997-1002 (1996).
5. Fuzzi B, Rizzo R, Criscuoli L, et al. HLA-G expression in early embryos is a fundamental prerequisite for the obtainment of pregnancy. *Eur. J. Immunol.* 32, 311-315 (2002).
6. Noci I, Fuzzi B, Rizzo R, et al. Embryonic soluble HLA-G as a marker of developmental potential in embryos. *Hum. Reprod.* 20(1), 138-146 (2005).
7. Rizzo R, Baricordi OR. HLA-G expression and regulation in early embryos. *Am. J. Reprod. Immunol.* 56(1), 17 (2006).
8. Rizzo R, Melchiorri L, Stignani M, Baricordi OR. HLA-G expression is a fundamental prerequisite to pregnancy. *Human Immunol.* 68(4), 244-250 (2007).
9. Criscuoli L, Rizzo R, Fuzzi B, et al. Lacking of HLA-G expression in early embryos is not related to germinal defects or impairment in IL-10 embryos production. *Gynecological Endocrinology* 20(5), 264-269 (2005).
10. Rizzo R, Fuzzi B, Stignani M, et al. Soluble HLA-G molecules in follicular fluid: a tool for oocyte selection in IVF? *J. Reprod. Immunol.* 74(1-2), 133-42 (2007).
11. Rizzo R, Dal Canto MB, Stignani M, et al. Production of sHLA-G molecules by “in vitro” matured cumulus-oocyte complex. Submitted to *J. Reprod. Immunol.* (2008).
12. Borgatti M, Rizzo R, Canto MB, et al. Release of sICAM-1 in oocytes and in vitro fertilized human embryos. *PLoS ONE* 3(12), e3970 (2008).

## MHC and Reproduction

02-01

### HLA-G Expression and Regulation in Early Embryos

R Rizzo, OR Baricordi

Department of Experimental and Diagnostic Medicine, Section of Medical Genetics, University of Ferrara, Ferrara, Italy

Our previous data have evidenced that HLA-G expression in early embryos is a mandatory prerequisite for the development of pregnancy. The screening of soluble HLA-G molecules in embryos cultures supernatants 48–72 hr after *in vitro* fertilization (IVF) could allow the selection of embryos to be transferred with an elevated possibility of positive pregnancy outcome.

Different evidences have suggested that the transcription in fertilized oocyte is silenced during the early phases of the development with a possible role of maternal mRNA in the production of soluble HLA-G molecules by early embryos. Thus, we have hypothesized an oocyte selection based on HLA-G expression. For this, we have investigated the presence of soluble HLA-G molecules in follicular fluids, with positive results in a large percentage of specimens. Furthermore, these results were related to HLA-G production in early embryos obtained by the fertilization of the corresponding oocyte. These data have shown a significant correlation between follicular fluids and embryos HLA-G modulation. Moreover, we have identified by different techniques the precise HLA-G isoforms of the follicular fluids and early embryos supernatants. Both soluble HLA-G1 and HLA-G5 molecules were revealed in follicular fluids, whereas only sHLA-G1 antigens were detected in embryos supernatants.

Immunocytochemistry on follicular fluids cells have identified granulosa cells as producer of the HLA-G5 isoform and polymorphonuclear cells of the sHLA-G1 molecules. In summary, the detected relationship between sHLA-G1/HLA-G5 presence in follicular fluids and early embryos propose the follicular fluids analysis as a reliable tool for oocyte selection in IVF.

02-03

### MHC Class I Antigens as Markers of Reproductive Success

IL Sargent<sup>1</sup>, A Swales<sup>1</sup>, YQ Yao<sup>2</sup><sup>1</sup>Nuffield Department of Obstetrics and Gynaecology, University of Oxford, John Radcliffe Hospital, Oxford, UK; <sup>2</sup>Department of Obstetrics and Gynaecology, Tangdu Hospital, Fourth Military Medical University, Xi'an, China

HLA-G is thought to play a key role in implantation by modulating cytokine secretion to control trophoblast invasion and maintain a local immunosuppressive state. It differs from other class I molecules in that the gene can be alternatively spliced to produce four membrane-bound and three soluble isoforms. The existence of soluble forms of HLA-G extends the potential for its action. Not only could it be acting locally at the interface between extravillous cytotrophoblast and the maternal immune cells in the decidua but it may also enter the maternal blood stream and act systemically to influence maternal immune responses. The soluble isoforms have recently attracted much attention as their levels may be diagnostic of poor trophoblast invasion in miscarriage or pre-eclampsia and the implantation potential of IVF embryos. A number of studies have reported that early cleavage stage (day 2–3 post-fertilization) embryos which produce sHLA-G are more likely to form a pregnancy than those that do not. However, not all workers agree and we have been unable to find mRNA for soluble HLA-G in human embryos at this stage of development. Furthermore, there is new evidence that soluble HLA-G may not be secreted by trophoblast. The technological and biological implications of these findings will be discussed.

02-04

### Ontogeny and Role of the MHC in Early Development: Expression of the Full Length Isoform of HLA-G, HLA-G1 and its Soluble Counterpart HLA-G5 in Human Pre-implantation Embryos

V Shaikly<sup>1</sup>, I Morrison<sup>1</sup>, M Taranissi<sup>2</sup>, C Noble<sup>2</sup>, N Fernandez<sup>1</sup><sup>1</sup>Department of Biological Sciences University of Essex, Essex, UK; <sup>2</sup>Assisted Reproduction and Gynaecology Centre, London, UK



# Polymorphism in the 5' Upstream Regulatory and 3' Untranslated Regions of the HLA-G Gene in Relation to Soluble HLA-G and IL-10 Expression

Thomas Vauvert F. Hviid, Roberta Rizzo, Loredana Melchiorri, Marina Stignani, and Olavio R. Baricordi

**ABSTRACT:** The nonclassical human leukocyte antigen (HLA) class Ib gene HLA-G may be important for the induction and maintenance of immune tolerance between the mother and the semi-allogeneic fetus during pregnancy. Expression of HLA-G can influence cytokine and cytotoxic T-lymphocyte responses. Different HLA-G mRNA isoform expression patterns have been associated with HLA-G polymorphism, especially with a 14-bp insertion deletion polymorphism in the 3' untranslated region (3'UTR) of the HLA-G gene. A significantly high level of interleukin-10 (IL-10) secretion is observed in homozygous +14/+14-bp HLA-G peripheral blood mononuclear cells after lipopolysaccharide (LPS) stimulation. This study finds that polymorphism in the 5' upstream regulatory region (5'URR) of the HLA-G gene may also be implicated in differences in IL-10 secretion. However, this may also be due to linkage disequilibrium with the 14-bp polymorphism. A single-

nucleotide polymorphism located -477 bp from the start site of exon 1 had a significant association with IL-10 concentrations but not after correction ( $p = 0.011$ ;  $p_c = 0.154$ ). This polymorphism is located next to a heat shock element. Eighteen 5'-URR/3'-UTR HLA-G haplotypes were defined; one common homozygous genotype based on these haplotypes was significantly associated with a high IL-10 level after LPS stimulation compared to certain other genotypes. This study indicates that polymorphism in the 5'-URR of the HLA-G gene may have functional significance, although a new line of investigations is needed to elucidate these findings. *Human Immunology* 67, 53-62 (2006). © American Society for Histocompatibility and Immunogenetics, 2006. Published by Elsevier Inc.

**KEYWORDS:** HLA-G; sHLA-G; Regulatory region; 3'UTR

## ABBREVIATIONS

ELISA	enzyme-linked immunosorbent assay
HLA	human leukocyte antigen
HSE	heat shock element
HSF1	heat shock factor 1
IL-10	interleukin-10
LPS	lipopolysaccharide

NK	natural killer
PBMCs	peripheral blood mononuclear cells
SNP	single-nucleotide polymorphism
5'URR	5' upstream regulatory region
3'UTR	3' untranslated region

## INTRODUCTION

Human leukocyte antigen (HLA)-G is a nonclassical HLA class Ib gene located on the short arm of chromo-

some 6 in the major histocompatibility complex. It resembles the classical HLA class Ia genes in structure but has a very limited polymorphism, and HLA-G transcripts are alternatively spliced into seven different isoforms, whereas three are potentially soluble (HLA-G5 to

*Department of Clinical Biocchemistry, Roskilde University Hospital, Roskilde, Denmark (T.V.F.H.), Department of Clinical Biocchemistry, Hillerød Hospital, Hillerød, Denmark (T.V.F.H.), Department of Experimental and Diagnostic Medicine, Section of Medical Genetics, University of Ferrara, Ferrara, Italy (R.R., L.M., M.S., O.R.B.), Department of Experimental and Diagnostic Medicine, Biotechnology Center, University of Ferrara, Ferrara, Italy (O.R.B.).*

*Address reprint requests to: Thomas Vauvert F. Hviid, MD, PhD, Roskilde University Hospital, 7-13 Kogevej, DK-4000 Roskilde, Denmark.*

*Tel: +45-4732-5622. Fax: +45-4632-1615.*

*This study was supported by a grant from the Foundation of Olga Bryde Nielsen.*

*Received September 26, 2005.*

*Human Immunology* 67, 53-62 (2006)  
© American Society for Histocompatibility and Immunogenetics, 2006  
Published by Elsevier Inc.

0198-8859/06/\$-see front matter  
doi:10.1016/j.humimm.2005.12.003

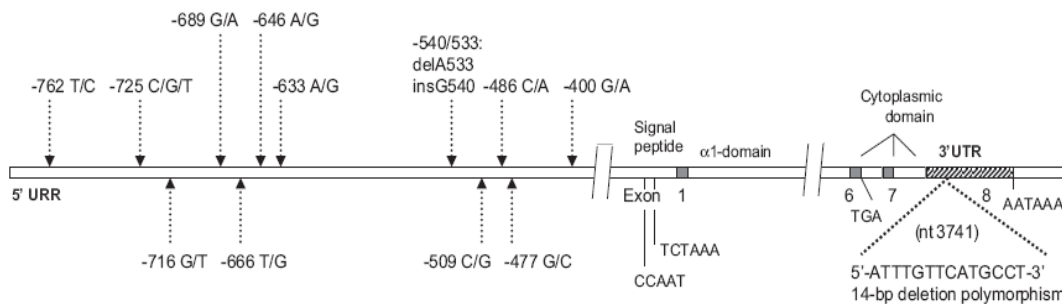

FIGURE 1 The 5' upstream regulatory region (5'URR) and the 3' untranslated region (3'UTR) of the HLA-G gene. The polymorphisms depicted in the 5'URR are shown in relation to the start site of exon 1.

-G7) [1–7]. HLA-G transcripts have been detected in many different tissues; however, under normal conditions, HLA-G protein has been detected only in trophoblast cells in the placenta, in some monocytes and T cells, and in the thymus [1, 8, 9]. HLA-G may have a role in the suppression of immune responses and contribute to long-term immune escape or tolerance [10–12]. HLA-G seems to be able to inhibit both a cytotoxic T lymphocyte response and natural killer (NK) functions [13]. Furthermore, antigen-presenting cells that have been transfected with HLA-G can prevent the proliferation of CD4<sup>+</sup> T cells and apparently direct these cells toward immunosuppression [12]. Finally, soluble (sHLA-G) expression seems to be able to induce CD8<sup>+</sup> T cell apoptosis through the Fas/FasL pathway [14, 15]. Expression of HLA-G in organ transplantation may be associated with a better prognosis [16, 17]. Detection of sHLA-G in the culture media from preimplantation embryos before transfer to the woman during *in vitro* fertilization treatments is associated with a higher implantation rate and pregnancy success [18–21]. Yet, no explanation of why only some embryos express detectable HLA-G exists. Several studies have linked abnormal expression of membrane-bound HLA-G and especially sHLA-G with certain complications of pregnancy such as preeclampsia, spontaneous abortion, and *abruptio placentae* [20, 22–26]. Polymorphisms in the HLA-G gene have been associated with risk of preeclampsia and spontaneous abortion, with autoimmune disease, and with susceptibility to asthma; however, some of these associations are controversial [27–31]. A few studies have found associations between HLA-G mRNA expression or detection of sHLA-G and HLA-G genotype [7, 27, 32–34]. We and others have found an association between a 14-bp polymorphism in the HLA-G 3' untranslated region (3'UTR) and HLA-G mRNA expression and alternative splicing, as well with sHLA-G concentrations in sera [7, 27, 33, 35, 36]. The genotype of the 14-bp polymorphism is also associated with differences in interleukin-10 (IL-10) secretion from

peripheral blood mononuclear cells (PBMCs) after stimulation with lipopolysaccharide (LPS) [34].

Polymorphism in the 5' upstream regulatory region (5'URR) of the HLA-G gene has been described [29, 33, 37] (Fig. 1). As the list of possible importance of HLA-G expression in different aspects has grown, we found it interesting to further investigate the associations between HLA-G expression and HLA-G gene polymorphism. In this study, we have focused only on the relevance of polymorphisms in the 5'URR and in the 3'UTR (the 14-bp polymorphism) of the HLA-G gene in relation to secretion of sHLA-G and IL-10 in PBMCs and in LPS-stimulated PBMC cultures.

## MATERIALS AND METHODS

### Samples and Extraction of Genomic DNA

Peripheral blood samples were obtained from 61 healthy Caucasian donors (31 females and 30 males; mean age =  $35 \pm 10$ ; no female subjects were pregnant). Genomic DNA was extracted by a commercial kit (Nucleon; Amersham Biosciences, Buckinghamshire, UK) according to the manufacturer's instructions. In 47 donors selected by the 14-bp 3'UTR HLA-G genotype, further PBMC analysis was performed.

### Genotyping of the 14-bp Polymorphism in Exon 8 (3'UTR) of the HLA-G Gene

The 14-bp HLA-G polymorphism was genotyped by PCR performed as previously described [38]. Briefly, 100 ng of genomic DNA was amplified in a 25- $\mu$ l reaction, with final concentrations of the reagents as follows: Reaction Buffer (Roche, Basel, Switzerland) 1 $\times$ ; each dNTP (Roche) 0.2 mM; MgCl<sub>2</sub> (Roche) 1.5 mM; *Taq* polymerase (Roche) 0.75 Units; each primer (GE14HLA-G, RHG4) 10 pmol. The thermocycling conditions were as follows: 94°C for 2 min, 25 cycles of 94°C for 30 s, 64°C for 60 s, 72°C for 120 s, and then 72°C for 10 min. The amplified products were visualized

by electrophoresis on a 2.5% agarose gel (Invitrogen, Paisley, Scotland) containing ethidium bromide (0.5  $\mu\text{g/ml}$ ).

#### DNA Sequence Analysis of the HLA-G 5' Upstream Regulatory Region/Promoter Region

Direct DNA sequence analysis of the HLA-G 5' URR was performed. For DNA sequencing of the 5' URR a sequence between  $-1437$  and  $-18$  bp from the start site of transcription was PCR amplified: Genomic DNA was made up to a final volume of 50  $\mu\text{l}$  containing 30 mM Tris-HCl (pH 8.3), 50 mM KCl, 0.1% Triton X-100; 1.5 mM  $\text{MgCl}_2$ ; 0.1% Igepal-CA630; 0.2 mM each dNTP; 25 pmol of each primer (5KBHLAG, 5' AGC TTC ACA AGA ATG AGG TGG AGC 3' and PROHLAG3, 5' AAT GAG TCC GGG TGG GTG AGC GA 3'), and 1.25 units of *Taq* polymerase. Thermocycling conditions were as follows: The initial denaturation was 94°C for 2 min and the final extension step was 72°C for 10 min. PCR cycling consisted of the following: 35 cycles of 94°C for 30 s, 60°C for 60 s, and 72°C for 240 s. The PCR products of the HLA-G 5' URR/promoter region were DNA sequenced using a 310 DNA Analyzer (Applied Biosystems, Foster City, CA, USA). Primers for sequencing were as follows: G830F (5' URR), 5' CAC ACG GAA ACT TAG GGC TAC G 3' and for control sequencing (5' URR) G304R, 5' GCC AAG CGT TCT GTC TCA GTG T 3'.

#### HLA-G Haplotypes

The reconstruction of HLA-G haplotypes from polymorphism data in the 5' URR of the HLA-G gene [11 single-nucleotide polymorphisms (SNPs), one insertion polymorphism, one deletion polymorphism] and the 14-bp polymorphism in exon 8 was made by the PHASE program, Version 2.1, which implements a Bayesian statistical method for reconstructing haplotypes from population genotype data (<http://www.stat.washington.edu/stephens/software.html>) [39].

#### Lipopolysaccharide Stimulation of PBMC Cultures

PBMCs obtained by Ficoll centrifugation (Cedarlane, Hornby, Ontario, Canada) were resuspended in Iscove's medium (Biochrom, Berlin, Germany) with 10% fetal calf serum at a concentration of  $1 \times 10^6/\text{ml}$ . The PBMC cultures were stimulated with 10 ng/ml LPS (Calbiochem, La Jolla, CA, USA) for 48 h at 37°C as previously reported [34]. CD14<sup>+</sup> cell viability and percentages were evaluated by flow cytometry (FACS Vantage, BD Bioscience, Franklin Lakes, NJ, USA) using propidium iodide staining and an anti-human CD14-FITC-conjugated antibody (Cymbus Biotechnology Ltd, Hants, UK). For the determination of the temporal stability of the sHLA-G and IL-10 response to the LPS stimulus,

two blood samples were obtained from five subjects, spaced 15 days apart, and processed as described above.

#### HLA-G5/sHLA-G1 Enzyme-Linked Immunosorbent Assay (ELISA)

HLA-G5/sHLA-G1 levels in culture supernatants and in serum samples were assayed in triplicate as previously reported [18, 40–42] using as capture antibody the MoAb MEM-G9 (Exbio, Praha, Czech Republic), which recognizes the HLA-G molecule, in  $\beta$ 2-microglobulin-associated form, at a concentration of 20  $\mu\text{g/ml}$ . As detecting antibody an anti- $\beta$ 2-microglobulin MoAb conjugated with HRP was used (DakoCytomation, Rødovre, Denmark). The intra-assay coefficient of variation (CV) was 1.4% and the inter-assay CV was 4.0%. The limit of sensitivity was 1.0 ng/ml.

#### IL-10 ELISA

IL-10 concentrations were determined in triplicate in 1:10 diluted serum and undiluted culture supernatants using the commercially available Human IL-10 BioSource Immunoassay Kit (Human IL-10 US; BioSource, Camarillo, CA, USA) with a detection limit of 0.2 pg/ml. The intra-assay CV was 4% and the inter-assay CV was 7.5%.

#### Statistics

For each HLA-G polymorphism, the three genotypes were compared with respect to differences in the IL-10 concentrations in the PBMC culture supernatants after LPS stimulation. A Kruskal-Wallis test was performed for each polymorphism and *p* values were corrected for multiple comparisons by the Bonferroni method. Comparison of IL-10 concentrations between two HLA-G haplotypes was performed with the use of the Mann-Whitney test.

## RESULTS

The 5' URR of the HLA-G gene including all polymorphisms between  $-762$  and  $-400$  bp from the start site of exon 1 was analyzed by DNA sequencing in the 61 samples from healthy donors. Eleven SNPs, one single nucleotide insertion, and one deletion polymorphism were detected (Table 1, Fig. 1). The 14-bp polymorphism in exon 8 in the 3' UTR of the HLA-G gene was also genotyped. In only 8 of the 61 serum samples, sHLA-G5/sHLA-G1 could be detected (median 5.5 ng/ml, range 0.5–38.0). Therefore, no meaningful analysis of HLA-G 5' URR polymorphism and sHLA-G concentrations in the serum samples could be performed. However, it shall be noted that all 8 samples had either a  $-14/-14$  or  $-14/+14$  bp HLA-G genotype. Interleukin-10 could be detected in 19 of the 61 serum samples (median 1.4 pg/ml, range 0.5–81.8 pg/ml). This small

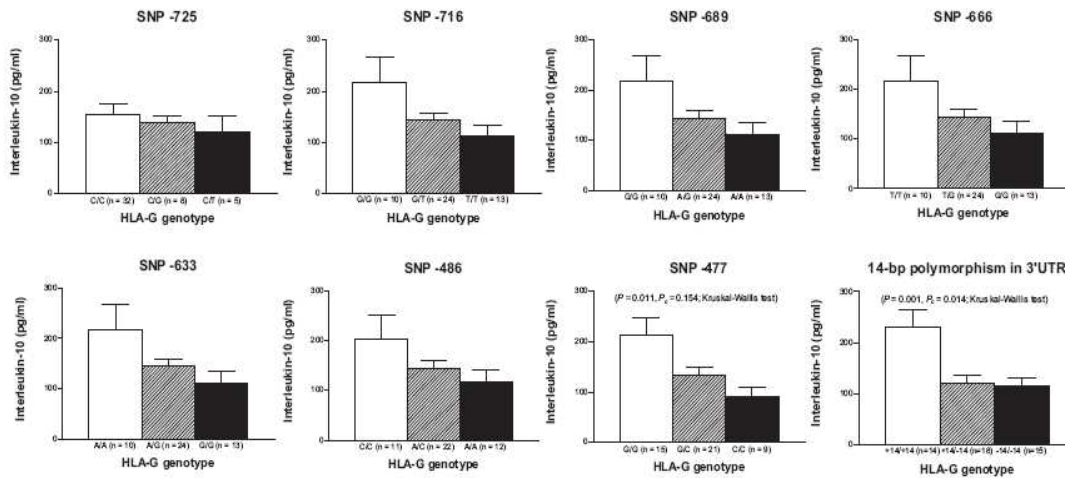

FIGURE 2 Interleukin-10 concentrations in LPS-stimulated PBMC cultures in relation to HLA-G genotypes of seven of the studied 5' URR HLA-G SNPs and the 14-bp polymorphism in the 3' UTR of the HLA-G gene.

number of IL-10 positive serum samples prevented further analysis of correlations between serum IL-10 and HLA-G genotype; it can be noted that all three 14-bp HLA-G genotypes were represented in the 19 IL-10 positive serum samples.

There were no difference between the levels of sHLA-G and the number of sHLA-G positive sera in male and female donors. To confirm the temporal stability of the sHLA-G and IL-10 response to LPS stimulation, two serial blood samples from five subjects were obtained. For each individual, sHLA-G and IL-10 production was temporally reproducible in response to the LPS stimulus (data not shown).

Forty-seven of the 61 healthy donors were investigated further; the 47 donors were initially chosen based on their 14-bp HLA-G genotype. IL-10 and sHLA-G concentrations were measured in media from PBMC cultures with or without stimulation with LPS. No sHLA-G could be detected in the unstimulated PBMC cultures. There were no associations between HLA-G polymorphisms and sHLA-G after LPS stimulation (mean sHLA-G concentration for all cultures  $\pm$  SEM:  $6.9 \pm 0.7$  ng/ml). Soluble HLA-G was detected in all LPS-stimulated cultures.

The mean IL-10 concentration without LPS stimulation was  $10.5 \pm 1.4$  pg/ml ( $\pm$ SEM). After LPS stimulation the mean IL-10 concentration was  $150.7 \pm 14.9$  pg/ml. Each of the 14 HLA-G polymorphisms was analyzed for differences in IL-10 concentration related to genotype after LPS stimulation. The only HLA-G polymorphism of the 14 polymorphisms investigated that was significantly associated with differences in IL-10 concentrations after LPS stimulation of PBMCs after

correction was the 14-bp polymorphism, with the highest IL-10 concentrations in the +14/+14 bp HLA-G genotypes ( $p = 0.001$ ,  $p_c = 0.014$ ; Kruskal-Wallis test).

For the -716 SNP, -689 SNP, -666 SNP, and -633 SNP, there was a trend toward differences in IL-10 concentrations between the specific SNP genotypes; however, they were not significant ( $p = 0.099$ ,  $p_c > 0.05$ ; Kruskal-Wallis test; Fig. 2). The test for the -477 SNP was significant but not after correction for multiple comparisons, with the G/G genotype being associated with the highest IL-10 concentrations ( $p = 0.011$ ,  $p_c > 0.154$ ; Kruskal-Wallis test; Fig. 2). Interestingly, samples with a G/G -477 SNP genotype also had a high IL-10 concentration in -14/+14 bp and -14/-14 bp HLA-G samples, indicating that this polymorphism may have an independent impact on IL-10 concentration and that the differences were not only a consequence of linkage disequilibrium between the G -477 SNP polymorphism and the +14-bp 3'UTR polymorphism.

HLA-G haplotypes based on the polymorphisms in the 5' URR and the 14-bp polymorphism were reconstructed with the use of the PHASE program. Eighteen different HLA-G haplotypes were defined (Table 1). Based on each of the HLA-G SNP genotype analyses described above, a consensus HLA-G 5' URR/3' UTR haplotype could be constructed, which was associated with a high IL-10 concentration after LPS stimulation of PBMCs (Table 2). This HLA-G haplotype was identical to the 5' URR.HLA-G-01 haplotype. A comparison of the IL-10 concentrations after LPS stimulation in 5' URR.HLA-G-01/5' URR.HLA-G-01 samples ( $253.8 \pm 55.6$  pg/ml; mean  $\pm$  SEM) and 5' URR.HLA-G-01/5' URR.HLA-G-09 samples ( $129.7 \pm 29.9$  pg/ml) re-

TABLE 1 List of HLA-G haplotypes in healthy Caucasian donors ( $n = 61$ ) based on polymorphisms in the 5' upstream regulatory region and the 14-bp polymorphism defined by the PHASE software

HLA-G haplotype	5' Upstream regulatory region												3' Untranslated region 14 bp at nt 3741	Allele frequency ( $N = 122$ )
	-762 bp	-725 bp	-716 bp	-689 bp	-666 bp	-646 bp	-633 bp	-540 to -533 bp	-509 bp	-486 bp	-477 bp	-400 bp		
5'URR.HLA-G-01	T	C	G	G	T	A	A	-	C	C	G	G	+	0.352 (43)
5'URR.HLA-G-02	T	C	G	G	T	A	A	-	C	C	G	G	-	0.098 (12)
5'URR.HLA-G-03	T	C	G	G	G	A	G	-	C	A	C	G	-	0.008 (1)
5'URR.HLA-G-04	T	G	G	G	G	A	G	-	C	A	C	G	-	0.008 (1)
5'URR.HLA-G-05	C	C	G	G	T	A	A	-	C	C	G	G	-	0.016 (2)
5'URR.HLA-G-06	C	C	T	A	G	A	G	-	C	C	C	G	-	0.016 (2)
5'URR.HLA-G-07	C	C	T	A	G	A	G	-	C	A	G	G	-	0.025 (3)
5'URR.HLA-G-08	C	C	T	A	G	A	G	-	C	A	C	G	+	0.025 (3)
5'URR.HLA-G-09	C	C	T	A	G	A	G	-	C	A	C	G	-	0.262 (32)
5'URR.HLA-G-10	C	C	T	A	G	A	G	DelA533	G	A	C	G	-	0.025 (3)
5'URR.HLA-G-11	C	C	T	A	G	G	G	-	C	A	G	A	+	0.016 (2)
5'URR.HLA-G-12	C	G	T	A	G	A	G	-	C	A	G	G	-	0.008 (1)
5'URR.HLA-G-13	C	G	T	A	G	A	G	-	C	A	C	G	+	0.016 (2)
5'URR.HLA-G-14	C	G	T	A	G	A	G	-	C	A	C	G	-	0.057 (7)
5'URR.HLA-G-15	C	T	T	A	G	A	G	-	C	A	C	G	-	0.008 (1)
5'URR.HLA-G-16	C	T	T	A	G	A	G	insG540	C	A	G	A	+	0.008 (1)
5'URR.HLA-G-17	C	T	T	A	G	A	G	insG540	G	A	G	A	+	0.041 (5)
5'URR.HLA-G-18	C	T	T	A	G	A	G	insG540	G	A	G	A	-	0.008 (1)

**TABLE 2** Consensus 5'URR/3'UTR HLA-G haplotype in relation to high IL-10 concentration after LPS stimulation

5' Upstream regulatory region												3' Untranslated region
-762 bp	-725 bp	-716 bp	-689 bp	-666 bp	-646 bp	-633 bp	-540 to -533 bp	-509 bp	-486 bp	-477 bp	-400 bp	14 bp at nt 3741
-	-	G	G	T	-	A	-	-	(C)	G	-	+

sulted in a  $p$  value of 0.038 (Mann-Whitney test; Fig. 3). The 5'URR.HLA-G-02 and 5'URR.HLA-G-09 haplotypes were associated with a low IL-10 concentration after LPS stimulation.

## DISCUSSION

We have previously reported that the 14-bp polymorphism in the 3'UTR of the HLA-G gene (exon 8) is associated with differences in IL-10 concentrations after LPS stimulation of PBMCs. The HLA-G genotype homozygous for the presence of the 14-bp sequence is associated with a significantly higher level of IL-10 in the cell culture medium after LPS stimulation [34]. The 14-bp 3'UTR polymorphism is also associated with differences in serum levels of sHLA-G where the +14/+14 bp HLA-G genotype appears to be associated with no detectable serum-sHLA-G [33, 34]. The presence of the 14-bp sequence in exon 8 is also associated with differences in alternative splicing of HLA-G transcripts [7, 27, 35]. Finally, and quite interestingly, a +14/+14-bp HLA-G genotype of the fetus is associated with a significantly higher risk of preeclampsia in primiparas [27, 29] and the same genotype is associated with recurrent spontaneous abortion and unsuccessful *in vitro* fertilization treatments [30]. We also have evidence for an association

between the 14-bp HLA-G polymorphism and autoimmune disease (Rizzo *et al.*, in preparation).

However, all these differences in HLA-G expression and associations related to the 14-bp polymorphism in the 3'UTR of the HLA-G gene may be due to strong linkage disequilibrium to other sequence variation in the HLA-G gene. Several polymorphisms have been described in the 5'URR of the HLA-G gene [28, 33, 37] (Fig. 1). Therefore, we investigated polymorphisms in the 5'URR of the HLA-G gene (between -762 and -400 bp from the start site of exon 1) together with the 14-bp polymorphism in the 3'UTR in relation to sHLA-G and IL-10 secretion in PBMC cultures with and without LPS stimulation. No associations between HLA-G polymorphisms and sHLA-G after LPS stimulation were observed; sHLA-G could not be detected before LPS stimulation. However, we found associations between HLA-G polymorphisms and IL-10 concentrations after LPS stimulation as expected. Several SNPs had trends toward associations, however, they were far from significant. The -477 SNP HLA-G genotype reached significance but not after correction ( $p = 0.011$ ,  $p_c = 0.154$ ; Kruskal-Wallis test; Fig. 2). The only HLA-G polymorphism that was significantly associated with differences in IL-10 concentrations after LPS stimulation of PBMCs after correction was the 14-bp polymorphism, with the highest IL-10 concentrations in the +14/+14-bp HLA-G genotypes as previously reported ( $p = 0.001$ ,  $p_c = 0.014$ ; Kruskal-Wallis test; Fig. 2) [34]. However, samples with a G/G -477 SNP genotype had also a high IL-10 concentration in -14/+14 bp and -14/-14 bp HLA-G samples. These observations could indicate that the -477 SNP might have an independent impact on IL-10 concentration and that the differences were not only a consequence of linkage disequilibrium between the G -477 SNP polymorphism and the +14-bp 3'UTR polymorphism. Interestingly, the -477 and -486 SNPs are located very close to a putative heat shock element (HSE) that seems to be able to bind heat shock factor 1 (HSF1) as shown in Fig. 4[43]. Heat shock elements are contiguous repeats of a pentanucleotide sequence, nGAAn, arranged in alternating orientation. These elements are located in the promoter region of genes encoding heat shock proteins [44]. Stress to the

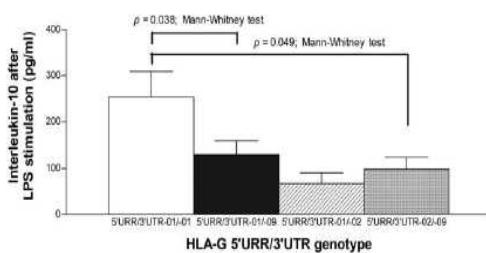

**FIGURE 3** Interleukin-10 concentrations in LPS-stimulated PBMC cultures in relation to two of the 5'URR/3'UTR HLA-G genotypes, namely, the homozygous 5'URR.HLA-G-01/5'URR.HLA-G-01 and the heterozygous 5'URR.HLA-G-01/5'URR.HLA-G-09 (5'URR.HLA-G-01/5'URR.HLA-G-01 and 5'URR.HLA-G-01/5'URR.HLA-G-09:  $n = 8$ , 5'URR.HLA-G-01/5'URR.HLA-G-02:  $n = 2$ ; 5'URR.HLA-G-02/5'URR.HLA-G-09:  $n = 4$ ).

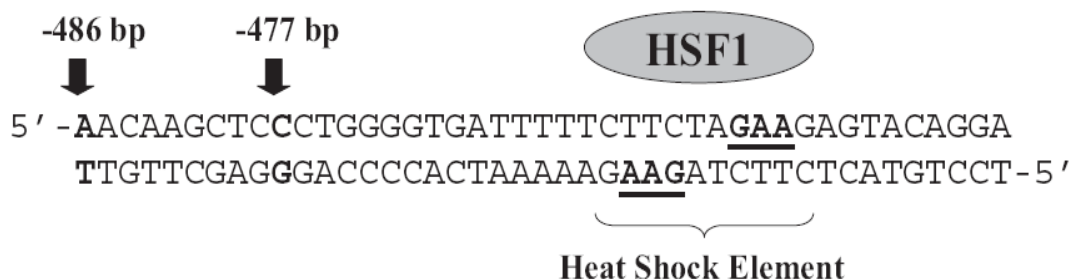

FIGURE 4 The heat shock element in the 5' upstream regulatory region (5'URR) of the HLA-G gene. Two of the investigated SNPs (-486 and -477 bp from the start site of exon 1) are located close to the HSE in the 5'URR of the HLA-G gene, and especially the -477 bp SNP may be associated with differences in IL-10 response after LPS stimulation of PBMCs. HSF1, heat shock factor-1.

cell, e.g., hyperthermia, induces binding of HSF to HSE, which activates transcription. It has been shown that heat shock and arsenite can induce the expression of HLA-G in tumor cell lines [43]. This stress treatment of the cells did not induce the expression of the HLA-A, -B, -E, or -F gene transcripts. Stress-induced proteins may be implicated in the balance of the immune response during certain diseases [45]. Interestingly, *Hsf1*<sup>-/-</sup> deficient mice survive into adulthood but defects of the placenta, prenatal lethality, growth retardation, and female infertility are observed [46]. Furthermore, there is an elimination of the classical heat shock response and augmented tumor necrosis factor- $\alpha$  expression is seen. It can be speculated that the polymorphism at positions -477 and -486 may affect the binding of HSF1 to the HSE leading to initial differences in HLA-G expression and in cytokine expression, e.g., IL-10. However, further elucidation of this possibility needs a new line of experiments.

With the use of the PHASE program, HLA-G haplotypes based on the polymorphisms in the 5'URR and in the 14-bp polymorphism could be reconstructed. Eighteen HLA-G haplotypes were defined (Table 1). Based on each of the HLA-G SNP genotype analyses described above, a consensus HLA-G 5'URR/3'UTR haplotype was identified, which was associated with a high IL-10 concentration after LPS stimulation of PBMCs (Table 2). This HLA-G haplotype was identical to the 5'URR.HLA-G-01 haplotype (Table 1). Similarly, 5'URR/3'UTR HLA-G haplotypes associated with low-level IL-10 secretion after LPS stimulation were identified. The 5'URR.HLA-G-02 and 5'URR.HLA-G-09 haplotypes seemed to be associated with a low IL-10 concentration after LPS stimulation (Fig. 3).

A couple of common polymorphisms in the gene for Toll-like receptor 4 (TLR4), involved in the response to LPS, have been associated with slightly higher IL-10 production capacity *ex vivo* and *in vivo* [47]. It can be speculated that there might be a link between TLR4 and

HLA-G gene polymorphisms and differences in the IL-10 response; however, this would be an issue for further studies.

Although differences in IL-10 concentrations after LPS stimulation of PBMC cultures in relation to the HLA-G genotype were observed in this study, there seems to be no clear correlation with sHLA-G levels. However, differences in sHLA-G concentrations related to the HLA-G genotype may be observed over time, especially during the initial phases of the cultures. However, we have not yet studied these aspects in detail and further studies are needed. We have advocated that HLA-G alleles may be divided in two main groups based on polymorphisms in the 3'UTR and the 5'URR [7, 37]. Interestingly, Tan *et al.* have recently published a study supporting this notion [48]. Genotyping of the HLA-G promoter in three populations showed two common haplotypes separated by deep branches, which suggests that balancing selection is acting in the region. This could be in line with the hypothesis of "yin-yang" haplotypes [49]. The present study further supports possible functional significant differences between the two groups of HLA-G alleles/haplotypes.

Altogether, these results still point to the 3'UTR 14-bp HLA-G polymorphism as being the most important polymorphism regarding functional significance. However, partly because of the linkage disequilibrium between most of the different polymorphic sites, the possibility cannot be excluded that polymorphism in the 5'URR of the HLA-G gene may also have functional importance. Most importantly, specific HLA-G haplotypes are associated with (functional) differences in HLA-G expression. This may have importance in relation to HLA-G expression during implantation and pregnancy, in relation to the outcome of the pregnancy [18, 20, 29, 33], and in relation to some disorders with an immunological etiology, such as asthma, as well as

autoimmune disease and rejection in organ transplantation [16, 31, 50–52].

#### ACKNOWLEDGMENT

Thanks are extended to Birthe Larsen for skillful technical assistance.

#### REFERENCES

- Kovats S, Main EK, Librach C, Stubblebine M, Fisher SJ, DeMars R: A class I antigen, HLA-G, expressed in human trophoblasts. *Science* 248:220, 1990.
- Ishitani A, Geraghty DE: Alternative splicing of HLA-G transcripts yields proteins with primary structures resembling both class I and class II antigens. *Proc Natl Acad Sci USA* 89:3947, 1992.
- Ober C, Rosinsky B, Grimsley C, van der Ven K, Robertson A, Runge A: Population genetic studies of HLA-G: Allele frequencies and linkage disequilibrium with HLA-A1. *J Reprod Immunol* 32:111, 1996.
- Yamashita T, Fujii T, Watanabe Y, Tokunaga K, Tadokoro K, Juji T, Taketani Y: HLA-G gene polymorphism in a Japanese population. *Immunogenetics* 44:186, 1996.
- Hviid TV, Meldgaard M, Sørensen S, Morling N: Polymorphism of exon 3 of the HLA-G gene. *J Reprod Immunol* 35:31, 1997.
- Paul P, Cabestre FA, Ibrahim EC, Lefebvre S, Khalil-Daher I, Vazeux G, Quiles RM, Bermond F, Dausset J, Carosella ED: Identification of HLA-G7 as a new splice variant of the HLA-G mRNA and expression of soluble HLA-G5, -G6, and -G7 transcripts in human transfected cells. *Hum Immunol* 61:1138, 2000.
- Hviid TV, Hylenius S, Rorbye C, Nielsen LG: HLA-G allelic variants are associated with differences in the HLA-G mRNA isoform profile and HLA-G mRNA levels. *Immunogenetics* 55:63, 2003.
- Crisa L, McMaster MT, Ishii JK, Fisher SJ, Salomon DR: Identification of a thymic epithelial cell subset sharing expression of the class Ib HLA-G molecule with fetal trophoblasts. *J Exp Med* 186:289, 1997.
- Rebmann V, Busemann A, Lindemann M, Grosse-Wilde H: Detection of HLA-G5 secreting cells. *Hum Immunol* 64:1017, 2003.
- Carosella ED, Rouas-Freiss N, Paul P, Dausset J: HLA-G: A tolerance molecule from the major histocompatibility complex. *Immunol Today* 20:60, 1999.
- Ishitani A, Sageshima N, Lee N, Dorofeeva N, Hatake K, Marquardt H, Geraghty DE: Protein expression and peptide binding suggest unique and interacting functional roles for HLA-E, F, and G in maternal-placental immune recognition. *J Immunol* 171:1376, 2003.
- LeMaout J, Krawice-Radanne I, Dausset J, Carosella ED: HLA-G1-expressing antigen-presenting cells induce immunosuppressive CD4<sup>+</sup> T cells. *Proc Natl Acad Sci USA* 101:7064, 2004.
- Le Gal FA, Riteau B, Sedlik C, Khalil-Daher I, Menier C, Dausset J, Guillet JG, Carosella ED, Rouas-Freiss N: HLA-G-mediated inhibition of antigen-specific cytotoxic T lymphocytes. *Int Immunol* 11:1351, 1999.
- Fournel S, Aguerre-Girr M, Huc X, Lenfant F, Alam A, Toubert A, Bensussan A, Le Bouteiller P: Cutting edge: Soluble HLA-G1 triggers CD95/CD95 ligand-mediated apoptosis in activated CD8<sup>+</sup> cells by interacting with CD8. *J Immunol* 164:6100, 2000.
- Contini P, Ghio M, Poggi A, Filaci G, Indiveri F, Ferrone S, Puppo F: Soluble HLA-A, -B, -C and -G molecules induce apoptosis in T and NK CD8<sup>+</sup> cells and inhibit cytotoxic T cell activity through CD8 ligation. *Eur J Immunol* 33:125, 2003.
- Lila N, Amrein C, Guillemain R, Chevalier P, Latremouille C, Fabiani JN, Dausset J, Carosella ED, Charpentier A: Human leukocyte antigen-G expression after heart transplantation is associated with a reduced incidence of rejection. *Circulation* 105:1949, 2002.
- Creput C, Durrbach A, Menier C, Guettier C, Samuel D, Dausset J, Charpentier B, Carosella ED, Rouas-Freiss N: Human leukocyte antigen-G (HLA-G) expression in biliary epithelial cells is associated with allograft acceptance in liver-kidney transplantation. *J Hepatol* 39:587, 2003.
- Fuzzi B, Rizzo R, Criscuoli L, Noci I, Melchiorri L, Scarselli B, Bencini E, Menicucci A, Baricordi OR: HLA-G expression in early embryos is a fundamental prerequisite for the obtainment of pregnancy. *Eur J Immunol* 32:311, 2002.
- Noci I, Fuzzi B, Rizzo R, Melchiorri L, Criscuoli L, Dabizzi S, Biagiotti R, Pellegrini S, Menicucci A, Baricordi OR: Embryonic soluble HLA-G as a marker of developmental potential in embryos. *Hum Reprod* 20:138, 2005.
- Yie SM, Balakier H, Motamedi G, Librach CL: Secretion of human leukocyte antigen-G by human embryos is associated with a higher *in vitro* fertilization pregnancy rate. *Fertil Steril* 83:30, 2005.
- Sher G, Keskinetepe L, Batzofin J, Fisch J, Acacio B, Ahlering P, Ginsburg M: Influence of early ICSI-derived embryo sHLA-G expression on pregnancy and implantation rates: A prospective study. *Hum Reprod* 20:1359, 2005.
- Hara N, Fujii T, Yamashita T, Kozuma S, Okai T, Taketani Y: Altered expression of human leukocyte antigen G (HLA-G) on extravillous trophoblasts in preeclampsia: Immunohistological demonstration with anti-HLA-G specific antibody "87G" and anti-cytokeratin antibody "CAM5.2." *Am J Reprod Immunol* 36:349, 1996.
- Goldman-Wohl DS, Ariel I, Greenfield C, Hochner-Celnikier D, Cross J, Fisher S, Yagel S: Lack of human leukocyte antigen-G expression in extravillous tropho-



- blasts is associated with pre-eclampsia. *Mol Hum Reprod* 6:88, 2000.
24. Pfeiffer KA, Rebmann V, van der Ven K: Soluble histocompatibility antigen levels in early pregnancy after IVF. *Hum Immunol* 61:559, 2000.
  25. Steinborn A, Rebmann V, Scharf A, Sohn C, Grosse-Wilde H: Placental abruption is associated with decreased maternal plasma levels of soluble HLA-G. *J Clin Immunol* 23:307, 2003.
  26. Yie SM, Li LH, Li YM, Librach C: HLA-G protein concentrations in maternal serum and placental tissue are decreased in preeclampsia. *Am J Obstet Gynecol* 191:525, 2004.
  27. O'Brien M, McCarthy T, Jenkins D, Paul P, Dausset J, Carosella ED, Moreau P: Altered HLA-G transcription in pre-eclampsia is associated with allele specific inheritance: Possible role of the HLA-G gene in susceptibility to the disease. *Cell Mol Life Sci* 58:1943, 2001.
  28. Ober C, Aldrich CL, Chervoneva I, Billstrand C, Rahimov F, Gray HL, Hyslop T: Variation in the HLA-G promoter region influences miscarriage rates. *Am J Hum Genet* 72:1425, 2003.
  29. Hylenius S, Andersen AM, Melbye M, Hviid TV: Association between HLA-G genotype and risk of pre-eclampsia: A case-control study using family triads. *Mol Hum Reprod* 10:237, 2004.
  30. Hviid TV, Hylenius S, Lindhard A, Christiansen OB: Association between human leukocyte antigen-G genotype and success of *in vitro* fertilization and pregnancy outcome. *Tissue Antigens* 64:66, 2004.
  31. Nicolae D, Cox NJ, Lester LA, Schneider D, Tan Z, Billstrand C, Kuldaneck S, Donfack J, Kogut P, Patel NM, Goodenbour J, Howard T, Wolf R, Koppelman GH, White SR, Parry R, Postma DS, Meyers D, Blecker ER, Hunt JS, Solway J, Ober C: Fine mapping and positional candidate studies identify HLA-G as an asthma susceptibility gene on chromosome 6p21. *Am J Hum Genet* 76:349, 2005.
  32. Rebmann V, van der Ven K, Passler M, Pfeiffer K, Krebs D, Grosse-Wilde H: Association of soluble HLA-G plasma levels with HLA-G alleles. *Tissue Antigens* 57:15, 2001.
  33. Hviid TV, Rizzo R, Christiansen OB, Melchiorri L, Lindhard A, Baricordi OR: HLA-G and IL-10 in serum in relation to HLA-G genotype and polymorphisms. *Immunogenetics* 56:135, 2004.
  34. Rizzo R, Hviid TV, Stignani M, Balboni A, Grappa MT, Melchiorri L, Baricordi OR: The HLA-G genotype is associated with IL-10 levels in activated PBMCs. *Immunogenetics* 57:172, 2005.
  35. Hiby SE, King A, Sharkey A, Loke YW: Molecular studies of trophoblast HLA-G: Polymorphism, isoforms, imprinting and expression in preimplantation embryo. *Tissue Antigens* 53:1, 1999.
  36. Rousseau P, Le Discorde M, Mouillot G, Marcou C, Carosella ED, Moreau P: The 14 bp deletion-insertion polymorphism in the 3' UT region of the HLA-G gene influences HLA-G mRNA stability. *Hum Immunol* 64:1005, 2003.
  37. Hviid TV, Sorensen S, Morling N: Polymorphism in the regulatory region located more than 1.1 kilobases 5' to the start site of transcription, the promoter region, and exon 1 of the HLA-G gene. *Hum Immunol* 60:1237, 1999.
  38. Hviid TV, Hylenius S, Hoegh AM, Kruse C, Christiansen OB: HLA-G polymorphisms in couples with recurrent spontaneous abortions. *Tissue Antigens* 60:122, 2002.
  39. Stephens M, Smith NJ, Donnelly P: A new statistical method for haplotype reconstruction from population data. *Am J Hum Genet* 68:978, 2001.
  40. Fournel S, Huc X, Aguerre-Girr M, Solier C, Legros M, Praud-Brethenou C, Moussa M, Chaouat G, Berrebi A, Bensussan A, Lenfant F, Le Bouteiller P: Comparative reactivity of different HLA-G monoclonal antibodies to soluble HLA-G molecules. *Tissue Antigens* 55:510, 2000.
  41. Menier C, Saez B, Horejsi V, Martinozzi S, Krawiec-Radanne I, Bruel S, Le Danff C, Reboul M, Hilgert I, Rabreau M, Larrad ML, Pla M, Carosella ED, Rouas-Freiss N: Characterization of monoclonal antibodies recognizing HLA-G or HLA-E: New tools to analyze the expression of nonclassical HLA class I molecules. *Hum Immunol* 64:315, 2003.
  42. Fainardi E, Rizzo R, Melchiorri L, Vaghi L, Castellazzi M, Marzola A, Govoni V, Paulino E, Tola MR, Granieri E, Baricordi OR: Presence of detectable levels of soluble HLA-G molecules in CSF of relapsing-remitting multiple sclerosis: Relationship with CSF soluble HLA-I and IL-10 concentrations and MRI findings. *J Neuroimmunol* 142:149, 2003.
  43. Ibrahim EC, Morange M, Dausset J, Carosella ED, Paul P: Heat shock and arsenite induce expression of the nonclassical class I histocompatibility HLA-G gene in tumor cell lines. *Cell Stress Chaperones* 5:207, 2000.
  44. Yamamoto A, Mizukami Y, Sakurai H: Identification of a novel class of target genes and a novel type of binding sequence of heat shock transcription factor in *Saccharomyces cerevisiae*. *J Biol Chem* 280:11911, 2005.
  45. Morimoto RI, Santoro MG: Stress-inducible responses and heat shock proteins: New pharmacologic targets for cytoprotection. *Nat Biotechnol* 16:833, 1998.
  46. Xiao X, Zuo X, Davis AA, McMillan DR, Curry BB, Richardson JA, Benjamin JJ: HSF1 is required for extra-embryonic development, postnatal growth and protection during inflammatory responses in mice. *EMBO J* 18:5943, 1999.
  47. Schippers EF, van Veer C, van Voorden S, Martina CA, Huizinga TW, le Cessie S, van Dissel JT: IL-10 and toll-like receptor-4 polymorphisms and the *in vivo* and *ex vivo* response to endotoxin. *Cytokine* 29:215, 2005.



# HLA-G Expression is a Fundamental Prerequisite to Pregnancy

Roberta Rizzo, Loredana Melchiorri, Marina Stignani, and Olavio R. Baricordi

**ABSTRACT:** Human leukocyte antigen-G (HLA-G) is thought to play a key role in implantation by controlling trophoblast invasion and maintaining a local immunosuppressive state. The secretion of soluble HLA-G antigens (sHLA-G) by early embryos seems necessary for a successful implantation and could be a marker of increased pregnancy rate following *in vitro* fertilization. We have reviewed the results obtained during the last years (from 1987 to 2005). They overall confirmed the predictive role of sHLA-G production in pregnancy outcome. Furthermore, we have examined the technical procedures utilized, with a particular attention to the monoclonal antibodies used in the enzyme-linked immunosorbent assay (ELISA)

techniques. New functional roles for HLA-G molecules in pregnancy could be suggested by the relationship observed between the presence of sHLA-G antigens in follicular fluids and sHLA-G expression in the corresponding fertilized oocyte. Furthermore, since maternal mRNA is fundamental for protein production in early embryos, the biologic role of the HLA-G 14 base pair polymorphism could be explored. *Human Immunology* 68, 244–250 (2007). © American Society for Histocompatibility and Immunogenetics, 2007. Published by Elsevier Inc.

**KEYWORDS:** HLA-G; IVF; embryo; follicular fluid

## ABBREVIATIONS

FF follicular fluid  
HLA-G human leukocyte antigen-G  
IVF *in vitro* fertilization

MoAb monoclonal antibody  
sHLA-G soluble HLA-G

## INTRODUCTION

Several studies have proposed the production of soluble human leukocyte antigen-G (sHLA-G) antigens by early embryos as a reliable marker of an increased chance of positive pregnancy outcome. Since the first investigations performed in 2002 [1], more than 2000 early-embryo supernatants have been analyzed by different research groups, confirming the fundamental role of HLA-G expression in pregnancy and validating the prognostic value of this test in the embryo transfer selection [2–6].

The first studies on HLA class I (HLA-I) expression by ovarian tissues and preimplantation human embryos started in the 1980s and reported contrasting results (Table 1). Both Dohr *et al.* and Desoye *et al.* performed

indirect immunofluorescence assays with W6/32 monoclonal antibody (MoAb)—specific for classical and non-classical HLA-I antigens—on human oocytes, ovarian tissues, and human preimplantation embryos [7, 8]. They revealed the expression of HLA class I (HLA-I) antigens only in granulosa cells. On the contrary, by means of the same MoAb, Roberts *et al.* demonstrated a strong positivity in some unfertilized human oocytes [9]. The first demonstration of HLA-G expression by preimplantation human embryos was obtained by Jurisicova *et al.* in 1996 by reverse transcriptase–polymerase chain reaction and immunocytochemistry techniques [10]. The authors were able to evidence HLA-G heavy chain–specific mRNA in about 40% of the 148 blastocysts tested. Furthermore, the presence of HLA-G specific mRNA in preimplantation embryos was associated with protein detection and increased blastocystic cleavage rate when compared with the embryos without HLA-G transcripts [11]. Moreover, the blastocysts with detectable HLA-G mRNA exhibited a significantly ( $p < 0.001$ ) greater number of blastomeres per embryo at 24 to 48

*From the Department of Experimental and Diagnostic Medicine, Section of Medical Genetics, University of Ferrara, Ferrara, Italy.*

*Address reprint requests to: Dr. R. Rizzo, University of Ferrara, Department of Experimental and Diagnostic Medicine, Section of Medical Genetics, Via L. Borsari, 46 44100 Ferrara, Italy; Tel: +39 0532 291383; Fax: +39 0532 291380; E-mail: rbr@unife.it.*

*Received June 15, 2006; accepted October 23, 2006.*

Human Immunology 68, 244–250 (2007)  
© American Society for Histocompatibility and Immunogenetics, 2007  
Published by Elsevier Inc.

0198-8859/07/\$—see front matter  
doi:10.1016/j.humimm.2006.10.012

TABLE 1 Published studies on HLA-G production in early embryos from IVF procedure

Study (listed chronologically)	Type of study	Technical approach	Samples	Antibodies	Results
Dohr <i>et al.</i> (1987) [7]	HLA-I expression	Immunofluorescence assay	Human oocytes Human ovarian tissues	W6.32 MoAb (HLA-I)	No HLA-I on cultured oocytes and zona pellucida HLA-I expression on granulosa cells
Desoye <i>et al.</i> (1988) [8]	HLA-I expression	Immunofluorescence assay	Human preimplantation embryos (IVF)	W6.32 MoAb (HLA-I)	No HLA-I on blastomeres and zona pellucida HLA-I expression on granulosa cells
Roberts <i>et al.</i> (1992) [9]	HLA-I expression	Immunocytochemistry	Human oocytes 6–8 days preimplantation embryos (IVF)	W6.32 MoAb (HLA-I)	No HLA-I on oocytes and blastocysts HLA-I expression on some unfertilized oocytes
Juriscova <i>et al.</i> (1996) [10]	HLA-G expression	Immunocytochemistry	164 blastocysts 21 pools of oocytes Preimplantation embryos (2, 4, 16 cells; IVF)	W6.32 MoAb (HLA-I) 4H84 mMoAb (HLA-G HC b <sub>2m</sub> free/HLA-I HC b <sub>2m</sub> free)	HLA-G expression on some oocytes, preimplantation embryos, blastocysts
Menicucci <i>et al.</i> (1999) [20]	Nonclassical sHLA-I expression	ELISA	41 early embryos supernatants (2–8 cells; 1–3 embryos; IVF)	W6.32 MoAb (HLA-I) TP25.99 (classical HLA-I HC)	Nonclassical sHLA-I expression in early embryo supernatants
Fazzi <i>et al.</i> (2002) [11]	sHLA-G expression and pregnancy (retrospective)	ELISA	285 early embryos supernatants (8 cells; 1–4 embryos; IVF, ICSI)	MEM-G9 capture MoAb (HLA-G) W6.32-biot detection MoAb (HLA-I)	sHLA-G expression in early embryo supernatants correlates with pregnancy
van Lierop <i>et al.</i> (2002) [22]	sHLA-G expression	ELISA	15 follicular fluids ? embryo culture supernatants (8 cells; IVF) <sup>a</sup> 44 blastocysts	56B MoAb (HLA-G denatured HC) G233 MoAb (HLA-G) BFL1 MoAb (HLA-G) <sup>a</sup> W6.32 MoAb (HLA-I)	No sHLA-G expression
Noriko <i>et al.</i> (2004) [24]	sHLA-G expression	ELISA	106 early embryo supernatants (8 cells, single embryos; IVF)	87G capture MoAb (HLA-G) MEM-G9 detection MoAb (HLA-G)	No sHLA-G expression
Sher <i>et al.</i> (2004) [2]	sHLA-G molecule expression and pregnancy outcome (retrospective)	ELISA	594 early embryo supernatants (8 cells, 1–4 embryos; ICSI)	MEM-G9 capture MoAb (HLA-G) Anti-b <sub>2m</sub> detection MoAb	sHLA-G expression in early embryo supernatants correlates with pregnancy
Noci <i>et al.</i> (2005) [6]	sHLA-G molecule expression and pregnancy outcome (retrospective)	ELISA	318 early embryos supernatants (8 cells, single embryos; IVF, ICSI)	MEM-G9 capture MoAb (HLA-G) W6.32-biot detection MoAb (HLA-I)	sHLA-G expression in early embryo supernatants correlates with pregnancy
Sher <i>et al.</i> (2005) [3]	sHLA-G molecule expression and pregnancy outcome (prospective)	ELISA	1404 early embryos supernatants (8 cells, single embryos; ICSI)	MEM-G9 capture MoAb (HLA-G) Anti-b <sub>2m</sub> detection MoAb	sHLA-G expression in early embryo supernatants correlates with pregnancy
Sher <i>et al.</i> (2005) [4]	sHLA-G molecule expression and pregnancy outcome (prospective)	ELISA	259 early embryos supernatants (8 cells, single embryos; ICSI)	MEM-G9 capture MoAb (HLA-G) Anti-b <sub>2m</sub> detection MoAb	sHLA-G expression in early embryo supernatants correlates with pregnancy
Yie <i>et al.</i> (2005) [5]	sHLA-G molecule expression and pregnancy outcome (retrospective)	ELISA	386 early embryos supernatants (8 cells, 1–4 embryos; ICSI)	4H84 capture MoAb (HLA-G HC b <sub>2m</sub> free/HLA-I HC b <sub>2m</sub> free) 3CG4 detection MoAb (HLA-G)	sHLA-G expression in early embryo supernatants and cleavage rate correlate with pregnancy

Abbreviations: HLA-G = human leukocyte antigen-G; IVF = *in vitro* fertilization; sHLA-G = soluble human leukocyte antigen-G; ELISA = enzyme-linked immunosorbent assay; ICSI = intracytoplasmic sperm injection.

<sup>a</sup>? = undefined.

hours after fertilization. These data proposed a variable expression of HLA-G during the critical period of preimplantation embryonic development and suggested the important role of this molecule in the survival of human embryos. The HLA-G antigen inhibition of the cytotoxic activity of natural killer cells [12] and CD8<sup>+</sup> lymphocytes [13], and the control of CD4<sup>+</sup> cell functions [14], could be at the basis of the immunotolerance of the semiallogenic fetus by the mother.

These observations confirmed in humans the results previously obtained in mice. In 1993, Warner and co-authors demonstrated the association between the reproductive advantage and the expression of Qa-2 molecules encoded by preimplantation embryo development gene, the homologue of human HLA-G gene [15]. The Qa-2 antigen can be detected on murine oocytes and early-cleavage and blastocyst-stage embryos [16], and it seems to act as a mediator of the transmission of mitogenic signals within the embryo and uterine environment in mice [17]. Because of these characteristics, Qa-2 and HLA-G antigens could share not only structural but also functional similarities, which could explain the findings on HLA-G expression in pregnancy.

In humans, another study confirmed the presence of HLA-G mRNA in the 44% of 108 day-3 preimplantation embryos from 25 couples attending an *in vitro* fertilization (IVF) procedure [18]; whereas Hiby *et al.* failed to detect HLA-G mRNA in two-cell and blastocyst-stage embryos [19], even when they analyzed only 11 embryos.

The first noninvasive investigation on nonclassical HLA-I expression in human early embryos was performed in 1999 by Menicucci *et al.* [20]. The authors performed an enzyme linked immunosorbent assay (ELISA) with a monoclonal antibody specific for both classical and nonclassical HLA-class I molecules (W6/32) and the TP25.99 MoAb that is specific only for classical HLA-class I antigens heavy chain. They demonstrated the presence of sHLA-G in the 90% of eight cell-stage embryo culture supernatants obtained by IVF. Furthermore, a significant association was observed between HLA-G production and embryo cleavage rate, confirming the results of Jurisicova *et al.* [11]. However, the study by Fuzzi *et al.* in 2002 [1] represented the first *in vivo* confirmation of the pivotal role of HLA-G molecules in pregnancy implantation. The authors analyzed the presence of sHLA-G molecules in 285 supernatants from cultures containing one to four embryos obtained from 101 IVF procedures. The ELISA technique was performed with MEM-G9 MoAb as capture antibody, specific for both sHLA-G1 molecules—generated from shedding or proteolytic cleavage of the HLA-G1 membrane bound—and HLA-G5 isoform, produced by mRNA alternative splicing, and the biotinylated W6.32

MoAb as detection. Two groups of patients were identified on the basis of the presence or absence of sHLA-G1/HLA-G5 molecules in the embryo culture supernatants. Although no clinical differences were observed between the two groups, positive embryo implantation occurred only in women with sHLA-G1/HLA-G5 molecules in embryo culture supernatants. This was the first *in vivo* observation made in humans that proved the importance of the expression of HLA-G products as a mandatory, but not sufficient, prerequisite for pregnancy positive outcome [21].

Further reports [2–6] were based on the detection of sHLA-G1/HLA-G5 molecules in supernatants from single embryo cultures, with HLA-G specific monoclonal antibodies (MEM-G1; MEM-G9; 4H84, 3C/G4), confirming the significant relationship between the secretion of these molecules by early embryos and a higher pregnancy rate. These studies investigated up to 2000 supernatants from single IVF and intracytoplasmic sperm injection embryos, with a recorded presence of sHLA-G from 36.2% [6] to 69.9% [5]. These data are in agreement with the 40% of HLA-G mRNA positivity found by Jurisicova *et al.*, suggesting the reliability of the detection techniques and proposing the presence of sHLA-G molecule as a marker for embryos transfer selection [10]. It is worth noting that Sher *et al.* [2–4] and Noci *et al.* [6] obtained their results with MEM-G9 MoAb as capture antibody and similar results were reported by Yie *et al.* [5] with 4H84 and 3C/G4 MoAbs as capture and detection, respectively.

On the contrary, Van Lierop *et al.* [22] proposed ELISA techniques based on three different MoAb combinations: G233 MoAb as coating and 56B as detection MoAb, 56B MoAb as coating and BFL.1 as detection MoAb, and W6.32 MoAb as coating and 56B as detection MoAb. They analyzed the culture supernatants from human IVF embryos at the eight-cell morula and at the blastocyst stage and failed to detect sHLA-G antigen. The three ELISA methods presented a substantial inconsistency, explained as a possible difference in the MoAbs specificity. BFL.1 MoAb HLA-G specificity was considered doubtful [23] because it failed to react with HLA-G transfected cell lines; 5A6B seemed to recognize the denatured HLA-G heavy chain and to have an affinity also for other proteins [22]. Noriko *et al.*, in a recent investigation using 87G and MEM-G9 MoAbs, were similarly unable to detect the presence of sHLA-G molecules in 106 embryo culture supernatants [24].

It is important to emphasize that, for the diagnostic test, it is necessary to use particular attention in the selection of the MoAbs for the ELISA technique. To overcome this problem, a collaborative study was recently held in Essen [25]. During this workshop, a comparison of different capture and detection MoAbs

was performed. The MEM-G9/anti- $\beta_2$ -m MoAbs system was proposed as the most reliable procedure to detect both sHLA-G1 and HLA-G5 molecules, whereas the 5A6G7/W6/32 biotinylated MoAbs system was suggested as the most specific for HLA-G5 isoform identification.

Since the majority of investigations on sHLA-G were carried out with antibodies specific for both sHLA-G1 and HLA-G5 molecules, different suggestions were advanced on the HLA-G isoforms produced by early embryos. Blaschitz *et al.* demonstrated that neither of the intron 4-containing isoforms, sHLA-G5 or -G6, were produced by human trophoblasts *in situ* or *in vitro* [26]. A recent paper by Yao *et al.* demonstrated the absence of HLA-G5 mRNA in two eight-cell stage embryos positive for immunofluorescence labeling performed with MEM-G/9 MoAb [27]. These results clearly suggest the predominance of sHLA-G1 isoform.

On this assumption, we have performed a specific ELISA test for HLA-G5 isoform [25] in two groups of embryo-cultured supernatants previously identified as negative or positive for MEM-G/9 reactivity. The preliminary results have demonstrated the absence of detectable HLA-G5 levels, confirming the sHLA-G1 nature of the molecules secreted by early embryos [27].

#### PERSPECTIVES

Several studies demonstrated that in the early developmental stage of the fertilized oocytes, the transcription is silenced and the activation of the human embryonic genome starts between the four- and eight-cell stages, approximately 70 hours after fertilization [28, 29]. For this, the maternal mRNA seems to be fundamental in the production of the sHLA-G molecules in early embryo culture supernatants [30]. This postulate suggests a more accurate analysis of the oocytes. Currently, the selection of oocytes eligible for IVF procedure is performed on the basis of morphologic parameters, but little evidence was obtained on their association with pregnancy outcome [31]. Follicular fluid (FF) represents a specific microenvironment for oocyte maturation, and a possible relationship was proposed between specific FF components and IVF outcome [32]. Furthermore, the ovulation is characterized by an inflammatorylike process with the migration into the follicle of macrophages and monocytes [33]. Overall, these considerations could suggest the analysis of FFs for the presence of sHLA-G molecules.

Our preliminary results on FFs of women admitted to IVF procedure have evidenced detectable sHLA-G molecules in 38.0% of the 50 FFs investigated. Surprisingly, the FFs have exhibited the highest concentration ( $65.1 \pm 70.6$  ng/ml; mean  $\pm$  SD) of sHLA-G recently reported in the analysis of biologic fluids, with a mean value twice

higher than plasma samples of healthy subjects ( $38.6 \pm 5.0$  ng/ml) [34]. Moreover, the specific ELISA performed in FFs for the detection of sHLA-G1 and HLA-G5 molecules has demonstrated the presence of both isoforms, with a percentage of 90% for sHLA-G1 molecules and 10% of HLA-G5 isoform. Concentrated follicular fluids (FF) and early embryos culture supernatants (EMB), defined positive and negative for sHLA-G presence with ELISA analysis, have been analysed with Western Blot technique. The MEM-G1 (sHLA-G1/HLA-G5) and 5A6G7 (HLA-G5) MoAbs have been used. The supernatants of 721.221G and HeLa-G5 cells have been used as controls. Briefly, concentrated and albumin depleted FFs and early embryos supernatants have been loaded on 8% sodium dodecyl sulfate (SDS)- polyacrylamide gel, electrophoresed at 80 V for 2 hours and blotted onto polyvinylidene difluoride (PVDF) membrane (Immobilon-P, Millipore, Billerica, MA, USA) by electrotransfer at 100 V for 45 minutes in 25 mM TRIS buffer, 190 mM glycine, 2% SDS, and 20% (vol/vol) methanol. Blocking was carried out with 5% nonfat dry milk, TRIS 100 mM pH 7.5, NaCl 150 mM overnight at 4°C. After two washes, the membrane was incubated with MEM-G1 or 5A6G7 MoAbs (10  $\mu$ g/ml) for 3 hours at room temperature, with gentle shaking. The sHLA-G molecules were detected using Protein-G HRP (BioRad, Hercules, CA, USA) at dilution of 1:5000 in 10 mM TRIS pH 8.0, 150 mM NaCl, and 0.1% Tween 20. Reactions were developed by chemiluminescence with SuperSignal enhanced chemiluminescence kit (SuperSignal West Pico system, Pierce, Rockford, IL, USA) and exposed to Hyperfilm ECL (Amersham Bioscience, Piscataway, NJ, USA). The Western blot analysis has confirmed the presence of these two sHLA-G isoforms in FFs and only of sHLA-G1 in embryo supernatants (Figure 1).

To investigate the possible functional significance of sHLA-G1/HLA-G5 molecules in FFs, we have related their presence to the sHLA-G production in four- to eight-cell early embryos obtained with the fertilization of the corresponding oocyte.

Preliminary results relative to the analysis of 50 FFs and of the corresponding embryos have demonstrated a significant relationship between the presence of sHLA-G in FFs and the embryos' production of sHLA-G ( $p = 1.3 \times 10^{-6}$ ; Fisher exact test). The receiver operating characteristic curve analysis has demonstrated a value of sensitivity of 95.8% and a specificity of 69.2% [35]. These results could suggest the analysis of sHLA-G in FFs as a reliable and noninvasive tool for oocyte selection to obtain embryos with an elevated capacity to modulate HLA-G expression.

A further interesting perspective is related to the possible role of 14 base pair (bp) polymorphism at the 3' untranslated region of the HLA-G gene in the regulation

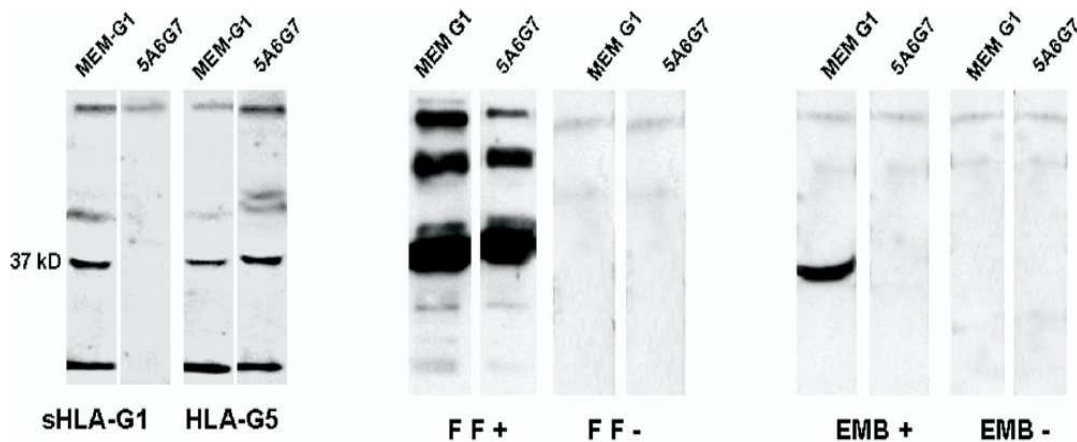

FIGURE 1 Western Blot analysis of concentrated follicular fluids (FF) and early embryo culture supernatants (EMB).

of HLA-G levels in early embryos. It is well known that the production of HLA-G molecules is regulated by a deletion/insertion polymorphism of a 14 bp sequence located in exon 8 of the HLA-G gene [36]. Previous investigations evidenced an increase of the  $^{+14/+14}$  bp genotype, characterized by instability of specific mRNA [37] and reduced protein production [35] in recurrent spontaneous abortion and unsuccessful IVF [38], and a higher susceptibility to autoimmune diseases (Rizzo R, Hvidt TVF, Rubini M et al., 2006, unpublished). Moreover, a pharmacogenetic role for the HLA-G 14 bp genotypes was demonstrated in the methotrexate therapy of rheumatoid arthritis [39]. Taking into consideration the importance of maternal mRNA in the expression of HLA-G molecules during the 72 hours after fertilization, further investigations could be proposed on the HLA-G 14 bp polymorphism distribution and the presence of the sHLA-G molecules in FFs.

Finally, it is worth noting that apoptosis seems to be one of the major biologic events in the ovary and that HLA-G molecules are characterized by a proapoptotic capacity. Previous reports clearly demonstrated the apoptotic capacities of sHLA-G1 molecules against T CD8<sup>+</sup> cells [40, 41]. On the opposite, a recent paper by Le Rond *et al.* demonstrated that HLA-G5 molecules can induce tolerance via nonapoptotic mechanisms in allograft response with the induction of immunosuppressive/regulatory T cells [42]. The detection of both HLA-G5 and sHLA-G1 molecules in FFs could propose further investigations on the possible differences in the functional role of these two isoforms in this microenvironment.

#### ACKNOWLEDGMENTS

We thank E. Weiss, Institut für Anthropologie und Genetik, Ludwig-Maximilians-Universität München (LMU), Germany for providing the supernatants 721.221G and HeLa-G5.

#### REFERENCES

1. Fuzzi B, Rizzo R, Criscuoli L, Noci I, Melchiorri L, Scarselli B, Bencini E, Menicucci A, Baricordi OR: HLA-G expression in early embryos is a fundamental prerequisite for the obtainment of pregnancy. *Eur J Immunol* 32:311, 2002.
2. Sher G, Keskinetepe L, Nouriani M, Roussev R, Batzofin J: Expression of sHLA-G in supernatants of individually cultured 46-h embryos: a potentially valuable indicator of 'embryo competency' and IVF outcome. *Reprod Biomed Online* 9:74, 2004.
3. Sher G, Keskinetepe L, Batzofin J, Fisch J, Acacio B, Ahlering P, Ginsburg M: Influence of early ICSI-derived embryo sHLA-G expression on pregnancy and implantation rates: a prospective study. *Hum Reprod* 20:1359, 2005.
4. Sher G, Keskinetepe L, Fisch JD, Acacio BA, Ahlering P, Batzofin J, Ginsburg M: Soluble human leukocyte antigen G expression in phase I culture media at 46 hours after fertilization predicts pregnancy and implantation from day 3 embryo transfer. *Fertil Steril* 83:1410, 2005.
5. Yie SM, Balakier H, Motamedi G, Librach CL: Secretion of human leukocyte antigen-G by human embryos is associated with a higher in vitro fertilization pregnancy rate. *Fertil Steril* 83:30, 2005.
6. Noci I, Fuzzi B, Rizzo R, Melchiorri L, Criscuoli L, Dabizzi S, Biagiotti R, Pellegrini S, Menicucci A, Baricordi OR: Embryonic soluble HLA-G as a marker of developmental potential in embryos. *Hum Reprod* 20:138, 2005.
7. Dohr GA, Motter W, Leitinger S, Desoye G, Urdl W, Winter R, Wilders-Truschning MM, Uchanska-Ziegler A: Lack of expression of HLA class I and class II molecules on the human oocyte. *J Immunol* 139:3550, 1987.
8. Desoye G, Dohr GA, Motter W, Winter R, Urdl W, Pusch H, Uchanska-Ziegler A: Lack of HLA class I and

- class II antigens on human preimplantation embryos. *J Immunol* 140:4157, 1988.
9. Roberts JM, Taylor CT, Melling GC, Kingsland CR, Johnson PM: Expression of the CD46 antigen, and absence of class I MHC antigen, on the human oocyte and preimplantation blastocyst. *Immunol* 75:202, 1992.
  10. Jurisicova A, Casper RF, MacLusky NJ, Librach CL: Embryonic human leukocyte antigen-G expression: possible implications for human preimplantation development. *Fertil Steril* 65:997, 1996.
  11. Jurisicova A, Casper RF, MacLusky NJ, Mills GB, Librach CL: HLA-G expression during preimplantation human embryo development. *Proc Natl Acad Sci U S A* 93:161, 1996.
  12. Rouas-Freiss N, Marchal RE, Kirszenbaum M, Dausset J, Carosella ED: The alpha1 domain of HLA-G1 and HLA-G2 inhibits cytotoxicity induced by natural killer cells: is HLA-G the public ligand for natural killer cell inhibitory receptors? *Proc Natl Acad Sci USA* 94:5249, 1997.
  13. Fournel S, Aguerre-Girr M, Huc X, Lenfant F, Alam A, Toubert A, Bensussan A, Le Bouteiller P: Cutting edge: soluble HLA-G1 triggers CD95/CD95 ligand-mediated apoptosis in activated CD8+ cells by interacting with CD8. *J Immunol* 164:6100, 2000.
  14. Bainbridge DR, Ellis SA, Sargent IL: HLA-G suppresses proliferation of CD4(+) T-lymphocytes. *J Reprod Immunol* 48:17, 2000.
  15. Warner CM, Panda P, Almquist CD, Xu Y: Preferential survival of mice expressing the Qa-2 antigen. *J Reprod Fertl* 99:145, 1993.
  16. Warner CM, Gollnick SO, Flaherty L, Goldbard SB: Analysis of Qa-2 antigen expression by preimplantation mouse embryos: possible relationship to the preimplantation-embryo-development (Ped) gene product. *Biol Reprod* 36:611, 1987.
  17. Xu Y, Jin P, Warner CM: Modulation of preimplantation embryonic development by antisense oligonucleotides to major histocompatibility complex genes. *Biol Reprod* 48:1042, 1993.
  18. Cao W, Brenner CA, Alikani M, Cohen J, Warner CM: Search for a human homologue of the mouse Ped gene. *Mol Human Reprod* 5:541, 1999.
  19. Hiby SE, King A, Sharkey A, Loke YW: Molecular studies of trophoblast HLA-G: polymorphism, isoforms, imprinting and expression in preimplantation embryo. *Tissue Antigens* 53:1, 1999.
  20. Menicucci A, Noci I, Fuzzi B, Criscuoli L, Scarselli G, Baricordi O, Mattiuz PL: Non-classic sHLA class I in human oocyte culture medium. *Human Immunol* 60:1054, 1999.
  21. Le Bouteiller P: Major breakthrough in the HLA-G debate: occurrence of pregnancy in humans depends on the HLA-G status of preimplantation embryos. *Eur J Immunol* 32:309, 2002.
  22. Van Lierop MJ, Wijnands F, Loke YW, Emmer PM, Lukassen HG, Braat DD, van der Meer A, Mosselman S, Joosten I: Detection of HLA-G by a specific sandwich ELISA using monoclonal antibodies G233 and 56B. *Mol Human Reprod* 8:776, 2002.
  23. Blaschitz A, Hutter H, Leitner V, Pilz S, Wintersteiger R, Dohr G, Sedlmayr P: Reaction patterns of monoclonal antibodies to HLA-G in human tissues and on cell lines: a comparative study. *Human Immunol* 61:1074, 2000.
  24. Noriko S, Horotsugu H, Masanori Y, Takanori S, Motoko O, Katsuhiko H, Geraghty DE, Akiko I: Are in vitro fertilized eggs able to secrete soluble HLA-G? *Am J Reprod Immunol* 52Suppl 1P8, 2004.
  25. Rebmann V, Lemaout J, Rouas-Freiss N, Carosella ED, Grosse-Wilde H: Report of the Wet Workshop for Quantification of Soluble HLA-G in Essen, 2004. *Hum Immunol* 66:853, 2005.
  26. Blaschitz A, Juch H, Volz A, Hutter H, Daxboeck C, Desoye G, Dohr G: The soluble pool of HLA-G produced by human trophoblasts does not include detectable levels of the intron 4-containing HLA-G5 and HLA-G6 isoforms. *Mol Hum Reprod* 11:699, 2005.
  27. Yao YQ, Barlow DH, Sargent IL: Differential expression of alternatively spliced transcripts of HLA-G in human preimplantation embryos and inner cell masses. *J Immunol* 175:8379, 2005.
  28. Tesarik J, Kopečný V, Plachot M, Mandelbaum J, Da Lage C, Flechon JE: Nucleologenesis in the human embryo developing in vitro: ultrastructural and autoradiographic analysis. *Dev Biol* 115:193, 1986.
  29. Braude P, Bolton V, Moore S: Human gene expression first occurs between the four- and eight-cell stages of preimplantation development. *Nature* 332:459, 1988.
  30. Sargent I: Does 'soluble' HLA-G really exist? Another twist to the tale. *Mol Hum Reprod* 11:695, 2005.
  31. Coticchio G, Sereni E, Serrao L, Mazzone S, Iadarola I, Borini A: What criteria for the definition of oocyte quality? *Ann N Y Acad Sci* 1034:132, 2004.
  32. Baka S, Malamitsi-Puchner A: Novel follicular fluid factors influencing oocyte developmental potential in IVF: a review. *Reprod Biomed Online* 12:500, 2006.
  33. Gerard N, Caillaud M, Martoriati A, Goudet G, Lalmanach AC: The interleukin-1 system and female reproduction. *J Endocrinol* 180:203, 2004.
  34. Rudstein-Svetlicky N, Loewenthal R, Horejsi V, Gazit E: HLA-G levels in serum and plasma. *Tissue Antigens* 67:111, 2006.
  35. Zweig MH, Campbell G: Receiver-operating characteristics (ROC) plots: a fundamental evaluation tool in clinical medicine *Clin Chem* 39:571, 1993.
  36. Rizzo R, Hviid TV, Stignani M, Balboni A, Grappa MT, Melchiorri L, Baricordi OR: HLA-G genotype is associated with IL-10 levels in activated PBMC. *Immunogenetics* 57:172, 2005.

37. Hviid TV, Rizzo R, Christiansen OB, Melchiorri L, Lindhard A, Baricordi OR: HLA-G and IL-10 in serum in relation to HLA-G genotype and polymorphisms. *Immunogenetics* 56:135, 2004.
38. Hviid TV, Hylenius S, Lindhard A, Christiansen OB: Association between human leukocyte antigen-G genotype and success of in vitro fertilization and pregnancy outcome. *Tissue Antigens* 64:66, 2004.
39. Rizzo R, Rubini M, Covoni M, Padovan M, Melchiorri L, Stignani M, Carturan S, Ferretti S, Trotta F, Baricordi OR: HLA-G 14 bp polymorphism regulates the methotrexate response in rheumatoid arthritis. *Pharmacogenet Genomics* 16:615, 2006.
40. Solier C, Aguerre-Girr M, Lenfant F, Campan A, Berrei A, Rebmann V, Grosse-Wilde H, Le Bouteiller P: Secretion of pro-apoptotic intron 4-retaining soluble HLA-G1 by human villous trophoblast. *Eur J Immunol* 32:3576, 2002.
41. Fournel S, Aguerre-Girr M, Huc X, Lenfant F, Alam A, Toubert A, Bensussan A, Le Bouteiller P: Cutting edge: soluble HLA-G1 triggers CD95/CD95 ligand-mediated apoptosis in activated CD8+ cells by interacting with CD8. *J Immunol* 164:6100, 2000.
42. Le Rond S, Azema C, Krawice-Radanne I, Durrbach A, Guettier C, Carosella ED, Rouas-Freiss N: Evidence to support the role of HLA-G5 in allograft acceptance through induction of immunosuppressive/regulatory T cells. *J Immunol* 176:3266, 2006.



## Soluble HLA-G molecules in follicular fluid: A tool for oocyte selection in IVF?

R. Rizzo<sup>a,\*</sup>, B. Fuzzi<sup>b</sup>, M. Stignani<sup>a</sup>, L. Criscuoli<sup>b</sup>, L. Melchiorri<sup>a</sup>, S. Dabizzi<sup>b</sup>,  
D. Campioni<sup>c</sup>, F. Lanza<sup>c</sup>, A. Marzola<sup>d</sup>, F. Branconi<sup>b</sup>, I. Noci<sup>b</sup>, O.R. Baricordi<sup>a</sup>

<sup>a</sup> Department of Experimental and Diagnostic Medicine, Section of Medical Genetics, University of Ferrara, Italy

<sup>b</sup> Department of Gynecology, Perinatal Medicine and Human Reproduction, University of Florence, Italy

<sup>c</sup> Department of Biomedical Sciences and Advanced Therapy, Section of Hematology, University of Ferrara, Italy

<sup>d</sup> Department of Experimental and Diagnostic Medicine, Section of Pathology, University of Ferrara, Italy

Received 13 October 2006; received in revised form 23 February 2007; accepted 27 February 2007

### Abstract

Currently, different approaches are used to select oocytes for *in vitro* fertilization (IVF) procedures, but they do not assure a significant association with the pregnancy outcome.

Since several studies have proposed the expression of HLA-G antigens in early embryos to be a possible marker of elevated implantation rate, we have investigated the presence of soluble HLA-G molecules in 50 follicular fluids (FFs). The results have shown soluble HLA-G antigens (sHLA-G) in 19/50 (38%) FFs. Furthermore, we have related the presence of sHLA-G molecules in FFs to detection of the soluble antigens in culture supernatants of the corresponding fertilized oocyte, evidencing a significant relationship ( $p = 1.3 \times 10^{-6}$ ; Fisher exact  $p$ -test). Specific ELISA and Western blot approaches identified both HLA-G5 and soluble HLA-G1 molecules in FFs while immunocytochemical analysis indicated polymorphonuclear-like and granulosa cells as responsible for production of sHLA-G1 and HLA-G5 molecules. In contrast, only sHLA-G1 antigens were detected in culture supernatants of fertilized oocytes.

Overall, these results suggest a role for sHLA-G molecules in the ovulatory process and propose the FFs analysis for sHLA-G molecule presence as a useful tool for oocyte selection in IVF.

© 2007 Elsevier Ireland Ltd. All rights reserved.

**Keywords:** HLA-G; IVF; Embryo; Follicular fluid

### 1. Introduction

Our previous results (Fuzzi et al., 2002; Noci et al., 2005), confirmed by following observations (Sher et al., 2004, 2005a,b; Yie et al., 2005), demonstrated that early

embryos from *in vitro* fertilization (IVF) procedures can secrete soluble HLA-G antigens (sHLA-G) into the culture supernatants. Detection was performed by specific Enzyme-Linked ImmunoSorbent Assay (ELISA). Screening of 4–8 cell-stage embryo supernatants for sHLA-G molecules provides a reliable tool for the selection of embryos to transfer with an elevated chance of a positive pregnancy outcome. Furthermore, since the most common complication of *in vitro* fertilization procedures (IVF) is multiple pregnancies, the selection and the reduction of transferred embryos could be interest-

\* Corresponding author at: Department of Experimental and Diagnostic Medicine, Section of Medical Genetics, University of Ferrara, Via L. Borsari, 46 44100 Ferrara, Italy. Tel.: +39 0532 291383; fax: +39 0532 291380.

E-mail address: rbr@unife.it (R. Rizzo).

ing. Nowadays, Italian legislation has promulgated new rules on medical assisted procreation (Law 40/2004), with a mandatory limit to produce and reimplant no more than three embryos. For this, the proposed screening for embryo selection has lost any functional implication in our country.

Several evidences suggest that transcription is silenced in the first phases of embryo development (Tesarik et al., 1986; Braude et al., 1988). This could support the possible pivotal role of maternal mRNAs in the production of sHLA-G molecules by early embryos reinforcing the importance of oocytes in the positive outcome of pregnancy, because they are the ‘keeper’ of maternal mRNAs. Currently, oocyte selection is performed on morphological parameters, without a clear association with a positive pregnancy outcome (Coticchio et al., 2004). Contrasting results were reported previously on classical and non-classical HLA class I antigen expression by oocytes. Dohr et al. (1987) and Desoye et al. (1988) failed to detect HLA class I (HLA-I) molecule expression in oocytes by immunohistochemical approaches, whereas Roberts et al. (1992) proposed HLA-I modulation in at least a percentage of oocytes. Furthermore, Jurisicova et al. (1996a,b) evidenced HLA-G mRNA expression in unfertilized oocytes while, in our previous study, we excluded the presence of sHLA-G molecules in the supernatants from unfertilized oocytes following 48–72 h cultures (Fuzzi et al., 2002). Taking into consideration these contrasting data, we focussed our attention on sHLA-G molecules in the follicular fluids (FFs). As is known, follicle activation is controlled by fine tuning of inhibitory and stimulatory soluble factors (Dorrington et al., 1987) and FFs represent an essential and specific microenvironment for regulation of ovarian function (Mendoza et al., 2002). Moreover, a possible relationship has been proposed between specific FF components and IVF outcome (Baka and Malamitsi-Puchner, 2006). For this, we hypothesized oocyte selection related to the presence of sHLA-G in FFs.

We have investigated the presence of sHLA-G antigens in 50 FFs, where we detected both sHLA-G1 and HLA-G5 molecules in a percentage of samples. The presence of sHLA-G molecules in FFs was related to the secretion of sHLA-G molecules by the corresponding fertilized oocyte, showing a significant correlation. ELISA and Western blotting analysis, performed with monoclonal antibodies (MoAbs) specific for HLA-G1 and HLA-G5 molecules, identified the different isoforms present in FFs and fertilized oocyte supernatants. Furthermore, the immunocytochemical approach detected the cell phenotypes responsible for production of HLA-

G isoforms in FFs. Finally, we have developed a new flow cytometric assay for rapid evaluation of sHLA-G levels in the hypothesis of a possible diagnostic utilization of the sHLA-G antigen research in FFs.

## 2. Material and methods

### 2.1. Patients

The study was performed on a group of infertile patients who underwent an IVF or intracytoplasmic sperm injection (ICSI) procedure at the Department of Gynecology, Perinatology and Reproductive Medicine University of Florence. Only one cycle, and from one to three FFs/fertilized oocytes per couple were considered. Following these criteria, 38 couples were recruited for the study (19 IVF, 19 ICSI). All patients received a similar stimulation regimen. Ovarian stimulation was induced with a recombinant FSH (Gonal F, Serono Industrie Farmaceutiche, Rome, Italy, or Puregon, Organon Italia, Milan, Italy) protocol starting from the 3rd to 5th day of the cycle after pituitary down-regulation with 0.1 mg/day triptorelin or 0.2 ml/day leuproulin (Decapeptyl 0.1, Ipsen, Milan, Italy; Enantone die, Takeda Italia, Rome, Italy) for 6–8 days prior to the expected period. Complete pituitary desensitization was confirmed by both low plasma estradiol <50 pg/ml and ultrasound examination to exclude ovarian cysts and verify that endometrial thickness was <5 mm. 10,000UI human chorionic gonadotrophin (hCG; Gonasi HP, Amsa, Milan, Italy; or, Ovitrelle, Serono Industrie Farmaceutiche, Rome, Italy) was administered when at least two follicles exceeded 17 mm in diameter. Oocyte recovery was performed by transvaginal ultrasound guidance and local analgesia 36 h after hCG administration. Luteal phase was supported with natural progesterone in oil, 50 mg/day (Prontogest f 100 mg, Amsa, Florence, Italy) or vaginally 200 mg × 2 (Prometrium; Rottapharm SpA, Milan, Italy) from the day of oocyte recovery. Embryo transfer was performed on the 3rd day post-oocyte collection. A single serum beta-hCG measurement was performed 12 days after embryo transfer. Collected oocytes were cultured in a four-well multidish (Nunc, Roskilde, Denmark) with 600 µl of culture medium (IVF or M3; Medi Cult, Jyllinge, Denmark). Each well contained only one oocyte. IVF or ICSI techniques were used for insemination. Oocyte fertilization was observed 16–18 h after insemination under an inverted microscope (TM/300, Nikon, Japan), the fertilization rate (FR) was calculated and the zygotes were transferred into fresh medium. Embryo morphology was evaluated after 48 h, the embryos were scored and transferred into fresh

medium until the transfer in uterus the day after. Embryos were evaluated for the number of blastomeres, regularity or irregularity of blastomeres and fragmentation percentage. Each of these parameters was scored and the sum of them gave embryo quality (Noci et al., 2005). The embryos analysed scored from grade A to C (data not shown). At 48 h from fertilization, 550  $\mu$ l of supernatants were collected from each human fertilized oocyte culture and stored at  $-20^{\circ}\text{C}$  until being tested for the presence of sHLA-G.

## 2.2. Follicular fluids

Individual FF samples were collected during oocyte retrieval from 50 follicles of 38 women (mean age:  $33.3 \pm 4.4$  years; mean  $\pm$  S.D.; range 26–41 years) undergoing controlled ovarian hyperstimulation. FFs were centrifuged at  $300 \times g$  for 10 min. The follicles had a mean diameter of  $18.9 \pm 1.9$  mm (range 15–24 mm). The FFs included in this study were non-haemorrhagic and not contaminated with flushing medium. The clarified supernatants were stored in aliquots at  $-20^{\circ}\text{C}$  until sHLA-G concentrations were determined. The remaining cells were washed twice with PBS and used for immunocytochemical analysis. Giemsa stain (Enien et al., 1998) (data not shown) permitted identification of three cell types in FF: polymorphonuclear-like cells, large epithelial cells and granulosa cells.

## 2.3. sHLA-G1/HLA-G5 ELISA

sHLA-G1, obtained from the proteolytic cleavage of membrane-bound HLA-G1, and HLA-G5, generated by mRNA alternative splicing, were assayed in fertilized oocyte culture supernatants and in FFs, in triplicate as reported in Essen Workshop on sHLA-G quantification (Rebmann et al., 2005) using as capture antibody the MoAb MEM-G9 (Exbio, Prague, Czech Republic) which recognizes the HLA-G molecule in beta2-microglobulin-associated form at the concentration of 20  $\mu\text{g}/\text{ml}$ . As detection antibody, an anti-beta2-microglobulin MoAb-HRP conjugated was used (Dako, Glostrup, Denmark). HeLa cell wild-type culture supernatants were used as negative control, and transfected HeLa-G5 cell (kindly provided by Prof. E. Weiss, Institut für Anthropologie und Genetik, LMU, München, Germany) as positive control. They were cultured in CD hybridoma AGt medium (Gibco, Auckland, NZ) added with 1% FCS and antibiotics. Culture supernatants were collected at cell confluence and concentrated by lyophilization procedure. Following depletion of albumin by the Albumin Depletion Kit

(Enchant Life Science kit; Pall Corporation, MI, USA), purification of the sHLA-G proteins was carried out as previously reported (Le Friec et al., 2003). The sHLA-G molecules obtained were used as standards at different dilutions.

The intra-assay coefficient of variation (CV) was 1.4%, and the inter-assay CV was 4.0%. The limit of sensitivity was 1.0 ng/ml. The detection limit was calculated with repeated measurements of a blank and a standard deviation being calculated, with the value of lower limit of detection being 3.29 standard deviations (S.D.) (Anderson, 1989). In this case, there is only a 5% chance of classifying a result in the wrong population and the lower limit of detection sample determinations are above this midway concentration with a probability of the 95%.

## 2.4. HLA-G5 ELISA

The specific ELISA for HLA-G5 isoform was performed as previously reported (Rebmann et al., 2005) with 5A6G7 as capture MoAb (Exbio, Prague, Czech Republic) and biotinylated W6/32 (Dako, Glostrup, Denmark) as detection MoAb. The fertilized oocyte culture supernatants and FFs were analysed in triplicate as previously reported. Transfected HeLa-G5 cell (kindly provided by Prof. E. Weiss, Institut für Anthropologie und Genetik, LMU, München, Germany) culture supernatants, purified as described earlier (HLA-G5/sHLA-G1 ELISA section), were used as standard. The intra-assay coefficient of variation (CV) was 2.0% and the inter-assay CV was 3.5%. The limit of sensitivity was 1.0 ng/ml, calculated as previously reported.

## 2.5. Western blotting

The presence of HLA-G molecules in FFs and 48 h fertilized oocyte supernatants were analysed by denaturing SDS-PAGE in a group of ELISA sHLA-G-positive samples. Briefly, 10 $\times$  concentrated and albumin-depleted FF and 100 $\times$  concentrated and albumin-depleted pooled fertilized oocyte supernatants were loaded on 10% SDS-polyacrylamide gel, electrophoresed at 80 V for 2 h and blotted onto PVDF membrane (Immobilon-P; Millipore, Billerica, MA, USA) by electrotransfer at 100 V for 45 min in 25 mM Tris buffer, 190 mM glycine, 2% SDS and 20% (v/v) methanol. Blocking was carried out with 5% non-fat dry milk, Tris 100 mM, pH7.5, NaCl 150 mM overnight at  $4^{\circ}\text{C}$ . After two washes, the membrane was incubated with MEM-G1 or 5A6G7 moAbs (10  $\mu\text{g}/\text{ml}$ ) for 3 h at room temperature with gentle shaking. The sHLA-G

molecules were detected using Protein-G HRP (BioRad, Hercules, CA, USA) at dilution of 1:5000 in 10 mM Tris pH8.0, 150 mM NaCl, 0.1% Tween 20. Reactions were developed by chemiluminescence with SuperSignal enhanced chemiluminescence kit (SuperSignal West Pico system; Pierce, Rockford, IL, USA) and exposed to Hyperfilm ECL (Amersham Bioscience, Piscataway, UK). Transfected 721.221-HLA-G1 and HeLa-G5 cell culture supernatants, purified as described earlier (HLA-G5/sHLA-G1 ELISA section), were used as positive control, and HeLa wild-type cell culture supernatants as negative control. They were loaded with the same sample concentration (10 ng). Molecular weights were determined with the BenchMark (Invitrogen, CA, US) pre-stained protein ladder (range 10–200 kDa).

#### 2.6. Immunocytochemical HLA-G expression in cells present in FF

*In situ* immunocytochemical analysis of HLA-G expression was performed in cells from FFs by an alkaline phosphatase anti-alkaline phosphatase (APAAP) technique (Campioni et al., 2004). Briefly, cells collected from FFs were washed in prewarmed Tris-buffered saline (TBS) (pH 7.6), air-dried and fixed in acetone and methanol (1:1) for 1 min. Cells were then incubated for 10 min with normal rabbit serum (Dako, Glostrup, Denmark) and washed in TBS. The primary MoAbs, anti-HLA-G MEM-G9 IgG1 or 5A7G6 IgG1 (both Exbio, Prague, Czech Republic), were added at a dilution of 1:100 followed by incubation with rabbit anti-mouse Ig (Dako Glostrup, Denmark), human serum and APAAP complex at the dilution of 1:20 (Dako, Glostrup, Denmark); a 30 min incubation period was used for each step. Alkaline phosphatase substrate was added, and the mixture incubated for 15 min. Samples were washed in TBS, stained with hematoxylin, mounted in permanent media, and examined by light microscopy (Leitz, Germany). Samples were tested also with isotype-matched irrelevant MoAbs (MoAbs to mouse IgG1, IgG2a, IgM; Dako, Glostrup, Denmark) as negative controls (Figs. 3b and 4b). Positive controls were performed on lipopolysaccharide-activated monocytes (Rizzo et al., 2005) (Figs. 3c and 4c).

#### 2.7. Dynabeads M-280 Tosylactivated conjugation with mAb MEM-G9

Dynabeads M-280 Tosylactivated (DynaL Biotech, Oslo, Norway) were prepared according to the manufacturer's recommendations. Briefly, the dynabeads were incubated for 24 h at 37 °C with MEM-G9 MoAb (Exbio,

Prague, Czech Republic), with a ratio of  $10^7$  dynabeads to 3  $\mu$ g mAb MEM-G9 MoAb. After several washes in recommended buffers, the Dynabead-MEM-G9 conjugates were stored in PBS, pH7.4 with 0.1% BSA and 0.02% sodium azide at 4 °C.

#### 2.8. Flow cytometry assay

Recently, CD45 has been proposed as a marker to distinguish granulosa cells (CD45- negative) from leukocytes (CD45-positive) (De Neubourg et al., 1996). Nevertheless, we analysed granulosa cells by FACS on the basis of their negativity for the leukocyte CD45 antigen (CD45-APC moAb (BD PharMingen, San Jose, CA, USA)). We identified only 0.5–1% of CD45-positive cells (leukocytes), whereas the other cells were CD45-negative (granulosa cells) (data not shown).

The flow cytometry technique was used also to analyze the presence of sHLA-G protein in FF. Transfected HeLa-G5 cells culture supernatants were used as positive control, and HeLa wild-type cells culture supernatants as negative control. The FFs and cell culture supernatants were incubated with  $10^6$  dynabeads—MEM-G9 conjugated for 1 h at 37 °C, then washed twice with PBS and labeled with anti  $\beta_2$ microglobulin-FITC MoAb (Biosdesign International, Saco, MN, USA) for 15 min at room temperature. The flow cytometric assay was performed on FACS Vantage (Becton Dickinson, San Jose, CA, USA) using standard settings and data analysis performed with Lysis software (Becton Dickinson).

#### 2.9. Statistics

Fisher's exact test was used to analyse the different frequencies in sHLA-G positivities.

These statistical analysis were conducted using Stat View software package (SAS Institute Inc., Cary, NC, USA). *p*-value of <0.05 was considered significant (two-tailed). The relationship between sHLA-G presence in FFs and in fertilized oocyte cultures was investigated with the Receiver Operating Characteristic (ROC) curve (Zweig and Campbell, 1993) analysis (JROCFIT software; John Hopkins University, Baltimore, MD, USA).

### 3. Results

#### 3.1. Soluble HLA-G molecules in FFs

Soluble sHLA-G1/HLA-G5 molecules were identified in 19 out of the 50 FFs investigated (38%). The concentrations in positive FFs ranged from 12.8 to 162.0 ng/ml, with a median value of 44.5 ng/ml.

3.2. Soluble HLA-G molecules in fertilized oocyte culture supernatants

The presence of sHLA-G1/HLA-G5 isoforms was investigated in the 50 culture supernatants of fertilized oocytes. The results demonstrated sHLA-G1/HLA-G5 molecules in the culture supernatants of 26 (52%) fertilized oocytescultures (median, 4.35 ng/ml; range, 1.2–131.0 ng/ml) from sHLA-G1/HLA-G5 positive and negative FFs. However, 18 sHLA-G positive supernatants correspond to the 19 sHLA-G positive FFs (94.7%), whereas the other 8 sHLA-G positive supernatants correspond to the 31 sHLA-G negative FFs (25.8%) ( $p = 1.3 \times 10^{-6}$ ; Fisher exact  $p$ -test) (Fig. 1). No differences were observed between the results obtained from ICSI and IVF fertilized oocytes.

3.3. Specific sHLA-G isoforms in FFs and fertilized oocyte supernatants

3.3.1. ELISA test

The investigation performed with 5A6G7 MoAb, specific for the HLA-G5 isoform, showed positive reaction in all 19 FFs positive for MEM-G9 MoAb. The con-

Table 1  
Frequencies and levels of sHLA-G1 and HLA-G5 molecules in positive FFs

FFs (n = 50) sHLA-G1		FFs (n = 50) HLA-G5	
Positive	n = 19 (38%)	Positive	n = 19 (38%)
Median (ng/ml)	36.7	Median (ng/ml)	5.6
Range (ng/ml)	12.8–142.1	Range (ng/ml)	2.2–19.2

centration of HLA-G5 molecules ranged from 2.2 to 19.2 ng/ml, with a median value of 5.6 ng/ml. HLA-G5 antigens were not detected in the 31 FFs negative for MEM-G9 MoAb. The sHLA-G1 concentration was calculated as the difference between sHLA-G1/HLA-G5 and HLA-G5 levels (Table 1).

Moreover, the analysis of fertilized oocyte supernatants indicated the presence of sHLA-G1 molecules (median, 4.35 ng/ml; range, 1.2–13.1 ng/ml) since no detectable HLA-G5 antigens were observed (Table 2).

3.3.2. Western blotting analysis

The western blotting analysis performed on FFs and 48 h fertilized oocyte culture supernatants positive and negative for the presence of sHLA-G1/HLA-G5

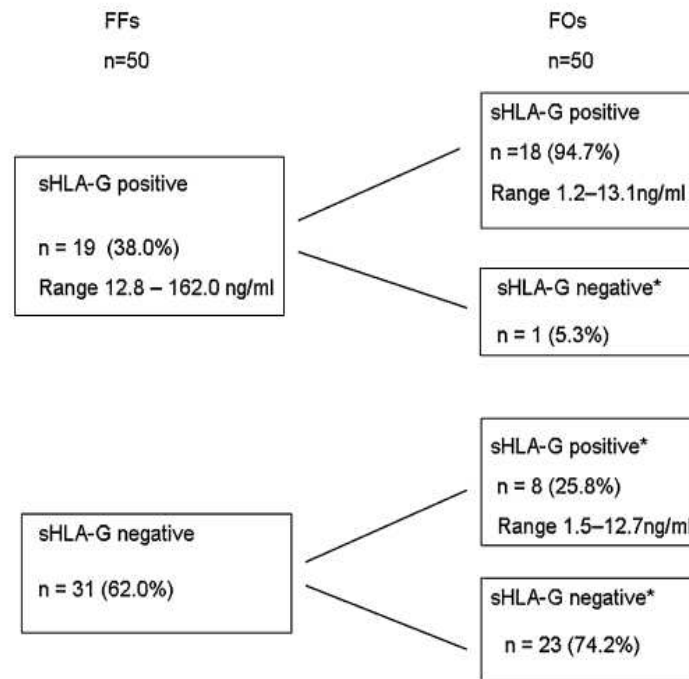

\* $p = 1.3 \times 10^{-6}$ ; Fisher exact  $p$  test

Fig. 1. Frequencies and levels of sHLA-G1/HLA-G5 (sHLA-G) in fertilized oocyte culture supernatants (FOs) according to sHLA-G positive and negative FFs.

Table 2  
Frequencies and levels of sHLA-G1 and HLA-G5 molecules in positive fertilized oocyte culture supernatants (FOs)

FOs, 48 h (n = 50) sHLA-G1		FOs, 48 h (n = 50) HLA-G5	
Positive	n = 26 (52.0%)	Positive	n = 0
Median (ng/ml)	4.4	Median (ng/ml)	
Range (ng/ml)	1.2–13.1	Range (ng/ml)	

molecules confirmed the ELISA results. Fig. 2a and b show the detection of both sHLA-G1 and HLA-G5 molecules in FFs but only of sHLA-G1 isoform in fertilized oocyte culture supernatants (Fig. 2a), where no HLA-G5 positivites were revealed (Fig. 2b).

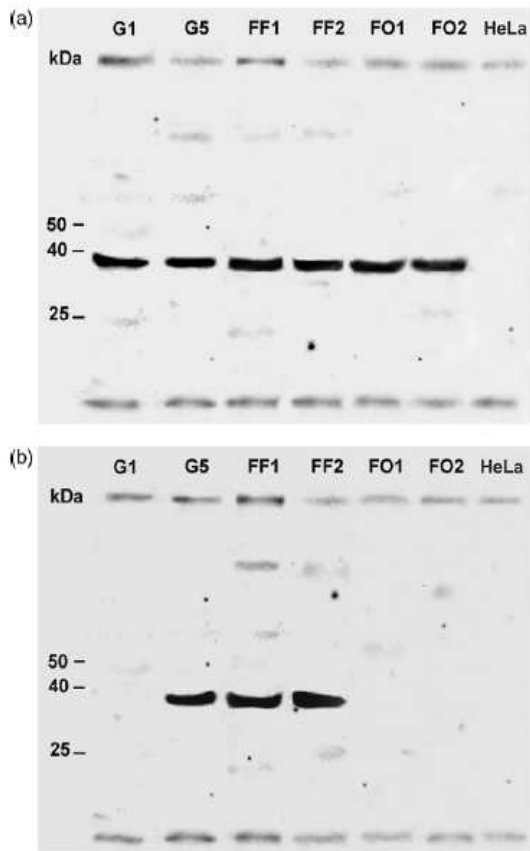

Fig. 2. Western blot analysis of 10× concentrated FFs and 100× concentrated 48 h fertilized oocyte culture supernatants (FOs), probed with (a) MEM-G1 or (b) 5A6G7 MoAbs. sHLA-G was revealed at 37 kDa. Samples were loaded with the same soluble HLA-G concentration (1 ng/μl) previously determined by ELISA test. The molecular weights were determined with the BenchMark (Invitrogen, CA, US) pre-stained protein ladder (range 10–200 kDa). Transfected 721.221-HLA-G1 (G1) and HeLa-G5 (G5) cell culture supernatants were used as positive control, and HeLa cell culture supernatants (HELA) as negative control.

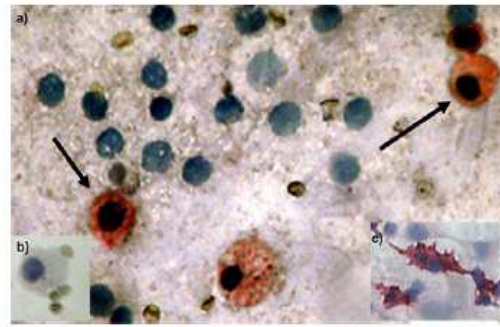

Fig. 3. (a) Immunocytochemical analysis of FF cells with 5A6G7 MoAb. Black arrows indicate positive granulosa cells. (b) Negative controls with isotype-matched non-relevant MoAb (mouse IgG1). (c) Positive control with HeLa HLA-G5 transfected cells.

### 3.3.3. Receiver Operating Characteristic (ROC)

The sHLA-G1/HLA-G5 presence in FFs could be considered a prognostic marker of the ability of fertilized oocytes to produce sHLA-G1 molecules with a sensitivity of 95.8% and a specificity of 69.2%.

### 3.3.4. Immunocytochemical HLA-G expression in FF cells

Immunocytochemical investigation showed the presence in FFs of different cell phenotypes, granulosa cells, polymorphonuclear-like and large epithelial cells in FFs, as previously evidenced by De Neubourg et al. (1996). The immunostaining performed with 5A6G7 MoAb, specific for HLA-G5 isoform, showed a positive result in granulosa cells (Fig. 3a), while significant reactivity of both polymorphonuclear-like cells and granulosa cells was obtained with

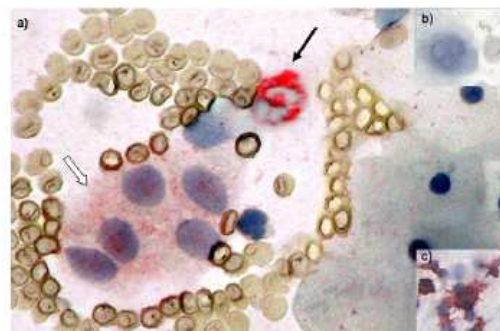

Fig. 4. (a) Immunocytochemical analysis of FF cells with MEM-G9 MoAb. Black arrows indicate positive polymorphonuclear-like cells; white arrows indicate positive granulosa cells. (b) Negative controls with isotype-matched non-relevant MoAb (mouse IgG1). (c) Positive control with JEG3 cells.

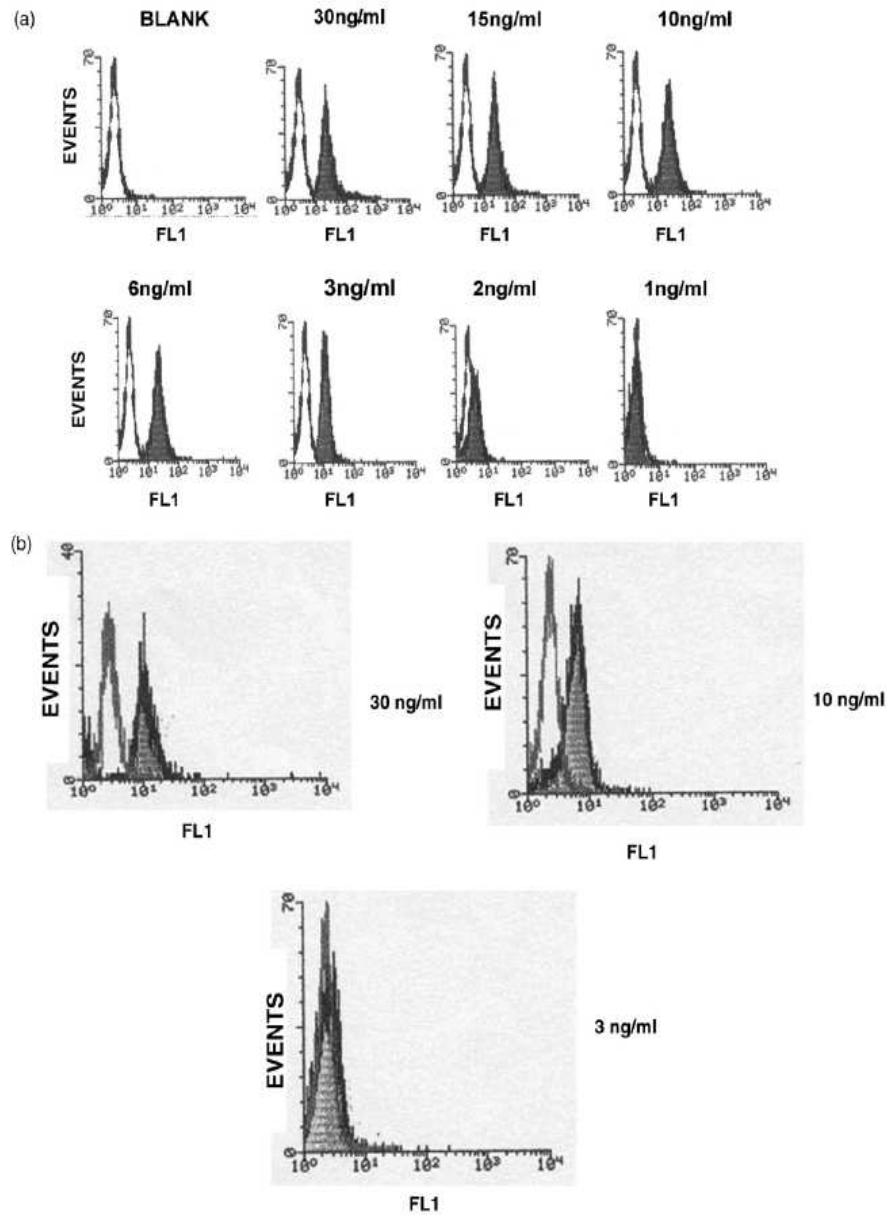

Fig. 5. (a) Flow cytometry analysis of HeLa cell culture supernatants (empty area) and transfected HeLa-G5 cells culture supernatants (dark area). (b) Flow cytometry analysis of FFs with different sHLA-G concentrations, accordingly to ELISA test (dark area). sHLA-G-negative FFs were used as negative controls (empty area). The cell culture supernatants and the FFs (200  $\mu$ l) were incubated with  $10^6$  dynabeads-MEM-G9 conjugates and labeled with anti  $\beta_2$  microglobulin-FITC MoAb. The detection limit of this assay was 3.0 ng/ml sHLA-G, according to ELISA results.

MEM-G9 MoAb (Fig. 4a). These results suggest granulosa cells as responsible for the production of the HLA-G5 isoform and the polymorphonuclear-like population could be a producer of sHLA-G1 molecules.

#### 3.4. Flow cytometry assay

The results obtained with the flow cytometric assay proposed this technique as a reliable and rapid procedure for investigation of soluble HLA-G molecules in FFs.

The comparison of the detection limits reported in ELISA and in the flow cytometry assay evidenced a limit of sensitivity for the flow cytometry procedure of 3.0 ng/ml (Fig. 5a). The intra-assay coefficient of variation (CV) was 2.5%, and the inter-assay CV was 5.0%.

The analysis of FFs failed to detect sHLA-G molecules in 2/19 (10.5%) FFs, that showed a positivity under 3.0 ng/ml in the ELISA technique (Fig. 5b).

#### 4. Discussion

Currently, intracytoplasmic and extracytoplasmic morphology are the main parameters used in non-invasive oocyte selection in IVF, but few lines of evidence have been obtained on a significant association with the pregnancy outcome (Coticchio et al., 2004).

Considering the importance of HLA-G molecules in human reproduction and the possible role of maternal mRNA in the expression of these molecules by early embryos, we investigated the presence of sHLA-G antigens in FFs. The results have demonstrated, sHLA-G molecules in a percentage of the FFs examined. Interestingly, soluble antigens in FFs showed the highest concentration since now observed in human biological fluids. The mean value of soluble antigens in positive specimens ( $65.1 \pm 70.6$  ng/ml; mean  $\pm$  S.D.) was twice higher than in plasma samples ( $38.6 \pm 5.0$  ng/ml) (Rudstein-Svetlicky et al., 2006). These elevated concentrations suggest a functional role for HLA-G molecules in pregnancy, not only in post-fertilization mechanisms but also during ovulation. Moreover, ELISA and Western blotting procedures revealed the presence of two soluble HLA-G isoforms in FFs: sHLA-G1 obtained from shedding and/or proteolytic cleavage of the membrane-bound HLA-G1 molecules, and HLA-G5 produced by alternative splicing mechanisms. We compared the qualitative and quantitative presence of these two isoforms in the 19 positive FFs, with a ratio of about 6:1 for sHLA-G1 isoform concentration (median: 36.7 ng/ml; range: 12.8–142.1 ng/ml) in comparison to HLA-G5 levels (median: 5.6 ng/ml; range: 2.2–9.2 ng/ml). It is of note that we observed only the concurrent presence in FFs of these two isoforms and not only a single isoform. These results suggest nonspecific activation mediated by the follicular microenvironment in different cell phenotypes which produce HLA-G molecules.

To identify the precise nature of these cells, we performed an immunocytochemical analysis with specific MoAbs. The results indicated granulosa cells as producer of the HLA-G5 isoform and the presence of membrane-bound HLA-G1 molecules in polymorphonuclear-like cells could be responsible for the sHLA-G1 production,

but further experiments should be necessary to validate this hypothesis and obtain a more precise cell phenotype definition. As known, granulosa cells are steroid producers that surround the oocyte as an avascular compartment (Nottola et al., 2006). Since it has been reported that progesterone can enhance HLA-G expression in cytotrophoblasts (Yie et al., 2006), the production of the HLA-G5 isoform by granulosa cells could be similarly related to steroid activity. Moreover, granulosa cells from normal women have been reported as positive for MHC class I and II expression and an increased MHC class II antigen modulation, responsible for activation of the immune response, was observed in patients with autoimmune ovarian failure (Hill et al., 1990). The production of HLA-G5 molecules demonstrated in our study could represent an inhibitory mechanism against the possible development of an autoimmune response that may strongly modify the cytokine balance of the follicular microenvironment.

Moreover, our data demonstrated the presence of polymorphonuclear-like cells expressing/secreted HLA-G1 molecules in FFs. Ovulation is characterized by an inflammatory-like process (Zolti et al., 1991; Machelon and Emilie, 1997) with the presence of polymorphonuclear cells in the ovary (Smith et al., 2005). These cells are related to different immunological functions in the female reproductive tissue, and the HLA-G1 presence in FFs could be related to angiogenic functions of polymorphonuclear cells (Brannstrom and Enskog, 2002). It has been reported that the enhancement of vascular activity in the corpus luteum is regulated by secretion of different growth factors and soluble molecules (Kaczmarek et al., 2005) and HLA-G molecules have demonstrated an angiogenic activity (Blaschitz et al., 1997; Le Bouteiller et al., 2003). The production of HLA-G molecules by polymorphonuclear-like cells could be influenced by the follicular microenvironment that might enhance specific pathways of expression.

Recently, an interesting discussion has tried to define the precise nature of the sHLA-G isoforms detected in the culture supernatants of early embryos (Yao et al., 2005). In the last years, a large percentage of ELISA investigations used MEM-G9 MoAb that recognizes both sHLA-G1 and HLA-G5 molecules. A recent study by Yao et al. (2005) demonstrated the absence of specific HLA-G5 mRNA in early embryos with a positive immunostaining with MEM-G9 MoAb that recognizes both isoforms. For this, the sHLA-G molecules detected in the supernatants of fertilized oocyte cultures should originate by shedding or cleavage of the membrane-bound HLA-G1 isoform. To confirm this suggestion, we



investigated with the 5A6G7 MoAb, specific for HLA-G5 molecules, the isoforms produced by the fertilized oocyte culture supernatants. The results obtained with ELISA and Western blotting procedures confirmed the presence of sHLA-G1 molecules, but not of HLA-G5 antigens.

To assess the possible role of sHLA-G molecules in FFs in relation to the oocyte functional capacities, we analysed further the association between the data obtained in FFs and the presence of sHLA-G1 molecules in the culture supernatants of the corresponding fertilized oocyte. We observed a significant correlation between sHLA-G molecule presence in the FF and sHLA-G1 secretion by fertilized oocyte. The receiver-operating characteristics (ROC) analysis suggested a sensitivity of 95.8% and a specificity of 69.2% for the presence of sHLA-G in FF in relation to sHLA-G1 expression by fertilized oocyte.

The correlation between the presence of sHLA-G molecules in fertilized oocyte supernatant and FF proposes a functional role for sHLA-G expression in the ovary compartment that leads to sHLA-G secreting embryos with a higher probability. The exact cause of this correlation is unknown, but it suggests the investigation of sHLA-G molecules in FF as a useful tool for the selection of oocytes with an increased capacity to express HLA-G antigens.

Until now, the detection of sHLA-G molecules in fertilized oocyte culture supernatants has been performed by ELISA techniques that normally require 5–6 h, while oocyte fertilization should occur within 3–5 h from the follicle collection. To overcome this problem, we generated a new flow cytometric assay that can detect the presence of sHLA-G molecules in FFs within 60 min. This assay failed to reveal sHLA-G molecules in 2/19 (10.5%) FFs that showed a positive labelling below 3.0 ng/ml according to the ELISA technique.

It is well known that oocytes selection represents a fundamental step in the IVF procedure. We have identified the presence of sHLA-G molecules in FFs, proposing a biological role for HLA-G molecules in the complex mechanism of the ovulatory process. Although complete validation is required in a larger number of FF/oocyte combinations, the significant relationship between HLA-G presence in FFs and sHLA-G1 production by fertilized oocytes could propose investigation of FFs as a useful tool for oocyte selection in IVF.

## References

- Anderson, D.J., 1989. Determination of the lower limit of detection. *Clin. Chem.* 35, 2152–2153.
- Baka, S., Malamitsi-Puchner, A., 2006. Novel follicular fluid factors influencing oocyte developmental potential in IVF: a review. *Reprod. Biomed. Online* 12, 500–506.
- Blaschitz, A., Lenfant, F., et al., 1997. Endothelial cells in chorionic fetal vessels of first trimester placenta express HLA-G. *Eur. J. Immunol.* 27, 3380–3388.
- Brannstrom, M., Enskog, A., 2002. Leukocyte networks and ovulation. *J. Reprod. Immunol.* 57, 47–60.
- Braude, P., Bolton, V., Moore, S., 1988. Human gene expression first occurs between the four- and eight-cell stages of preimplantation development. *Nature* 332, 459–461.
- Campioni, D., Punturieri, M., et al., 2004. 'In vitro' evaluation of bone marrow angiogenesis in myelodysplastic syndromes: a morphological and functional approach. *Leukemia Res.* 28, 9–17.
- Coticchio, G., Sereni, E., et al., 2004. What criteria for the definition of oocyte quality? *Ann. NY Acad. Sci.* 1034, 132–144.
- De Neubourg, D., Robins, A., et al., 1996. Flow cytometric analysis of granulosa cells from follicular fluid after follicular stimulation. *Hum. Reprod.* 11, 2211–2214.
- Desoye, G., Dohr, G.A., et al., 1988. Lack of HLA class I and class II antigens on human preimplantation embryos. *J. Immunol.* 140, 4157–4159.
- Dohr, G.A., Motter, W., et al., 1987. Lack of expression of HLA class I and class II molecules on the human oocyte. *J. Immunol.* 138, 3766–3770.
- Dorrington, J.H., Bendell, J.J., et al., 1987. Actions of growth factors in the follicle. *J. Steroid Biochem.* 27, 405–411.
- Enien, W.M., Chantler, E., Seif, M.W., Elstein, M., 1998. Human ovarian granulosa cells and follicular fluid indices: the relationship to oocyte maturity and fertilization in vitro. *Hum. Reprod.* 13 (5), 1303–1306.
- Fuzzi, B., Rizzo, R., et al., 2002. HLA-G expression in early embryos is a fundamental prerequisite for the obtainment of pregnancy. *Eur. J. Immunol.* 32, 311–315.
- Hill, J.A., Welch, W.R., et al., 1990. Induction of class II major histocompatibility complex antigen expression in human granulosa cells by interferon gamma: a potential mechanism contributing to autoimmune ovarian failure. *Am. J. Obstet. Gynecol.* 162, 534–540.
- Juriscova, A., Casper, R.F., et al., 1996a. Embryonic human leukocyte antigen-G expression: possible implications for human preimplantation development. *Fertil. Steril.* 65, 997–1002.
- Juriscova, A., Casper, R.F., et al., 1996b. HLA-G expression during preimplantation human embryo development. *Proc. Natl. Acad. Sci. USA* 93, 161–165.
- Kaczmarek, M.M., Schams, D., Ziecik, A.J., 2005. Role of vascular endothelial growth factor in ovarian physiology—an overview. *Reprod. Biol.* 5, 111–136.
- Le Bouteiller, P., Pizzato, N., et al., 2003. HLA-G, pre-eclampsia, immunity and vascular events. *J. Reprod. Immunol.* 59, 219–234.
- Le Fric, G., Laupeze, B., et al., 2003. Soluble HLA-G inhibits human dendritic cell-triggered allogeneic T-cell proliferation without altering dendritic differentiation and maturation processes. *Hum. Immunol.* 64, 752–761.
- Machelon, V., Emilie, D., 1997. Production of ovarian cytokines and their role in ovulation in the mammalian ovary. *Eur. Cytokine Netw.* 8, 137–143.
- Mendoza, C., Ruiz-Requena, E., et al., 2002. Follicular fluid markers of oocyte developmental potential. *Hum. Reprod.* 17, 1017–1022.
- Noci, I., Fuzzi, B., et al., 2005. Embryonic soluble HLA-G as a marker of developmental potential in embryos. *Hum. Reprod.* 20, 138–146.

- Nottola, S.A., Heyn, R., et al., 2006. Ultrastructural characteristics of human granulosa cells in a coculture system for in vitro fertilization. *Microsc. Res. Tech.* 69, 508–516.
- Rebmann, V., Lemaout, J., et al., 2004. Report of the Wet Workshop for quantification of soluble HLA-G in Essen. *Hum. Immunol.* 66, 853–863.
- Rizzo, R., Hviid, T.V., et al., 2005. The HLA-G genotype is associated with IL-10 levels in activated PBMCs. *Immunogenetics* 57, 172–181.
- Roberts, J.M., Taylor, C.T., et al., 1992. Expression of the CD46 antigen, and absence of class I MHC antigen, on the human oocyte and preimplantation blastocyst. *Immunology* 75, 202–205.
- Rudstein-Svetlicky, N., Loewenthal, R., et al., 2006. HLA-G levels in serum and plasma. *Tissue Antigens* 67, 111–116.
- Sher, G., Keskinetepe, L., et al., 2004. Expression of sHLA-G in supernatants of individually cultured 46-h embryos: a potentially valuable indicator of 'embryo competency' and IVF outcome. *Reprod. Biomed. Online* 9, 74–78.
- Sher, G., Keskinetepe, L., et al., 2005a. Influence of early ICSI-derived embryo sHLA-G expression on pregnancy and implantation rates: a prospective study. *Hum. Reprod.* 20, 1359–1363.
- Sher, G., Keskinetepe, L., et al., 2005b. Soluble human leukocyte antigen G expression in phase I culture media at 46 h after fertilization predicts pregnancy and implantation from day 3 embryo transfer. *Fertil. Steril.* 83, 1410–1413.
- Smith, M.P., Flannery, G.R., et al., 2005. Leukocyte origin and profile in follicular aspirates at oocyte retrieval. *Hum. Reprod.* 20, 3526–3531.
- Tesarik, J., Kopečný, V., et al., 1986. Nucleogenesis in the human embryo developing in vitro: ultrastructural and autoradiographic analysis. *Dev. Biol.* 115, 193–203.
- Yao, Y.Q., Barlow, D.H., Sargent, I.L., 2005. Differential expression of alternatively spliced transcripts of HLA-G in human preimplantation embryos and inner cell masses. *J. Immunol.* 175, 8379–8385.
- Yie, S.M., Balakier, H., et al., 2005. Secretion of human leukocyte antigen-G by human embryos is associated with a higher in vitro fertilization pregnancy rate. *Fertil. Steril.* 83, 30–36.
- Yie, S.M., Xiao, R., Librach, C.L., 2006. Progesterone regulates HLA-G gene expression through a novel progesterone response element. *Hum. Reprod.* 21, 2538–2544.
- Zolti, M., Ben-Rafael, Z., et al., 1991. Cytokine involvement in oocytes and early embryos. *Fertil. Steril.* 56, 265–272.
- Zweig, M.H., Campbell, G., 1993. Receiver-operating characteristics (ROC) plots: a fundamental evaluation tool in clinical medicine. *Clin. Chem.* 39, 561–577.

## HLA-G and Inflammatory Diseases

O.R. Baricordi\*, M. Stignani, L.Melchiorri and R. Rizzo

Laboratory of Immunogenetics, Section of Medical Genetics - Department of Experimental and Diagnostic Medicine - University of Ferrara, Ferrara, Italy

**Abstract:** HLA-G antigens are non classical HLA-class I molecules characterized by a low allelic polymorphism, a limited tissue distribution and the presence of membrane bound and soluble isoforms. The HLA-G antigens were firstly detected in cytotrophoblast cells at the feto-maternal interface where they maintain a tolerogenic status between the mother and the semiallogenic fetus. Recently a variable expression of HLA-G molecules has been documented in several autoimmune diseases, viral infections, cancer diseases and transplantation. Overall the presence of HLA-G molecules in both membranes bound and soluble isoforms was associated with tolerogenic functions against innate and adaptative cellular responses. HLA-G antigens are able to affect the cytotoxicity of natural killer and CD8+ T cells, CD4+ T lymphocyte functions and dendritic cell maturation.

In addition to the allelic polymorphism the HLA-G gene shows a deletion/insertion polymorphism of a 14 base pairs sequence (14bp) in the exon 8 at the 3' untranslated region. Several reports have associated the presence of the 14bp insertion allele (+14bp) to an unstable mRNA and a lower sHLA-G protein production, suggesting a different ability to counteract inflammation between genotypes.

We reviewed the literature on the expression of HLA-G antigens in autoimmune and allergic diseases and the possible functional role of these molecules in counteracting inflammation.

**Keywords:** HLA-G, inflammation, autoimmunity, immune response, genetic polymorphism.

The first report on the specific role of Human Leukocyte Antigens (HLA) in inducing the susceptibility to affections, such as Hodgkin's disease, was reported by Amiel JC. and coauthors in 1967 [1]. In the following years several studies identified hundreds of classical HLA class I and class II haplotypes behaving as genetic markers of different disorders [2, 3]. HLA determinants might be directly involved in the etiopathogenesis of the disease or could be only a marker of a disease gene, characterized by strong linkage disequilibrium with the HLA loci [4]. Recently it has been demonstrated that the HLA-G antigen, a new human MHC molecule, has a direct implication in the development/maintenance of autoimmune and inflammatory conditions [5]. These structures are currently defined as non classical HLA-class I antigens since they differ from classical HLA- A, B and C molecules for a reduced polymorphism and a restricted tissue distribution (Fig. 1). HLA-G antigens, as the classical HLA-class I molecules, are peptide presenting heterodimeric glycoproteins non-covalently associated with  $\beta$ 2-microglobulin. The allelic polymorphisms, located in exons 2, 3 and 4, characterize 30 alleles and one "null allele" [6]. A peculiar mRNA alternative splicing mechanism generates eight proteic isoforms, four membrane bound (HLA-G1 to -G4) and three soluble (HLA-G5 to -G7) [7] (Fig. 2). The membrane bound HLA-G1, its soluble counterpart HLA-G5 and the soluble HLA-G1 isoform, produced by the proteolytic release of the membrane bound HLA-G1 [8] are the most expressed isoforms with a clear biological function. The HLA-G1 and HLA-G5 structures are characterized

by three heavy chain domains, differently from the other isoforms which lack one or more globular domains.

A further polymorphism, characterized by the insertion/deletion of a 14 base pair sequence (14bp), has been recently detected in the exon 8 at the 3' untranslated region (UTR) of the gene [9,10]. The presence of the 14bp insertion was associated with mRNA instability and consequently a reduced production of HLA-G molecules [11-13] (Fig. 3).

The expression of HLA-G antigens was firstly described in trophoblast cells [14]. It is known that the placental trophoblast cells lack classical HLA-I and II antigens expression in order to avoid maternal immune response. However this deficiency of HLA expression activates natural killer (NK) cell lysis of target cells. Several "in vitro" studies have demonstrated the ability of HLA-G molecules, in both membrane and soluble isoforms, to preserve target cells, lacking classical HLA-class I antigens, from NK cell mediated cytotoxicity [15-19].

The molecular mechanisms that regulate HLA-G tolerogenic and anti-inflammatory functions have been reviewed by Carosella *et al* 2008 [5]. HLA-G molecules can display inhibitory functions against NK, T lymphocytes and antigen presenting cells by the direct binding of ILT-2 (LILRB1/CD85J), ILT-4 (LILRB2/CD85d) and KIR2DL4 (CD158d) receptors (20-24). These receptors produce an inhibitory signal that interferes with cellular activation. The interaction between soluble HLA-G isoforms and the CD8 receptor has shown to induce apoptosis in T cells by a Fas ligand/Fas mediated mechanism [25].

Membrane bound HLA-G molecules were identified in a restricted number of tissues in normal conditions, such as thymus, cornea, nail matrix, pancreas and erythroid and-

\*Address correspondence to this author at the Laboratory of Immunogenetics, Section of Medical Genetics, Department of Experimental and Diagnostic Medicine, University of Ferrara - Via Luigi Borsari, 46; I-44100 Ferrara - Italy; Tel: ++390532455382; Fax: ++390532455380; E-mail: bri@unife.it

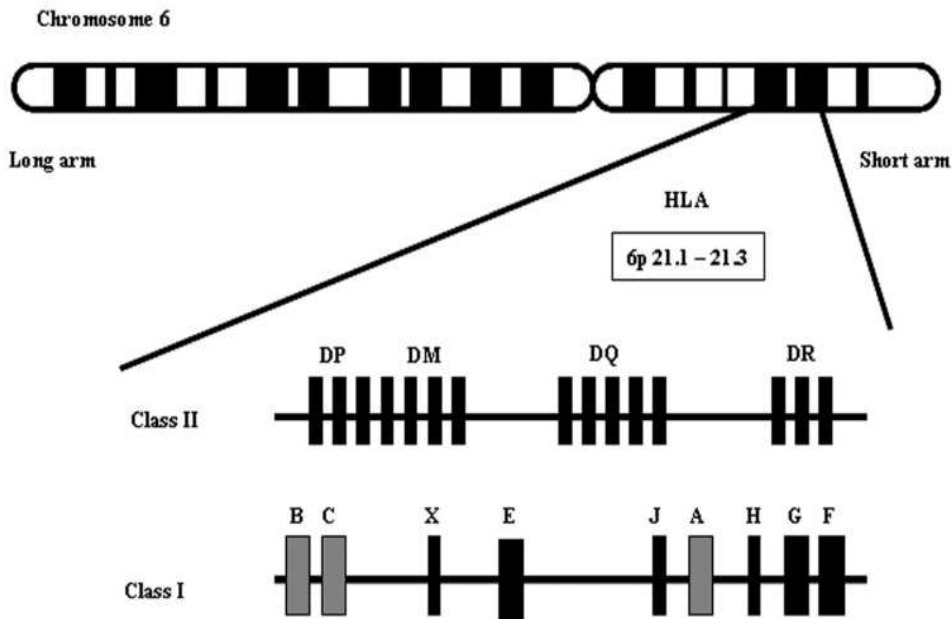

Fig. (1). Map of the human MHC on chromosome 6p21. Class I and class II HLA genes are shown in detail. Classical class I HLA genes are shown as blackened rectangles; non classical class I HLA genes are shown as gray-shaded rectangles.

dothelial precursors [26-28]. By means of a specific enzyme immunosorbent assay (ELISA), detectable amounts of soluble HLA-G molecules were identified in the serum/plasma of a percentage of healthy subjects [29]. The peripheral blood CD14+ monocyte cells were reported as the main producer of these circulating molecules following bacterial lipopolysaccharide (LPS) activation and interleukin, interferon and hormone up-modulation [13, 30].

Overall HLA-G molecules are able to generate, by direct or indirect mechanisms, an anti-inflammatory Th2 microenvironment, fundamental for a positive pregnancy outcome [31]. Recently the HLA-G molecules were associated with

the induction of immunosuppressive regulatory T cell and to angiogenic events [32-36].

The clearly demonstrated tolerogenic and anti-inflammatory functions mediated by membrane bound and soluble HLA-G molecules have been analyzed in different physiological and pathological conditions. HLA-G expression and modified HLA-G serum/plasma levels were found in pregnancy [37, 38], viral infection [39-42], cancer [43-48], transplantations [49-52] and autoimmune diseases [53, 54]. A further confirm of the functional role of HLA-G molecules in mediating tolerance has been recently provided by Feger [33]. The authors have identified a novel CD25 and

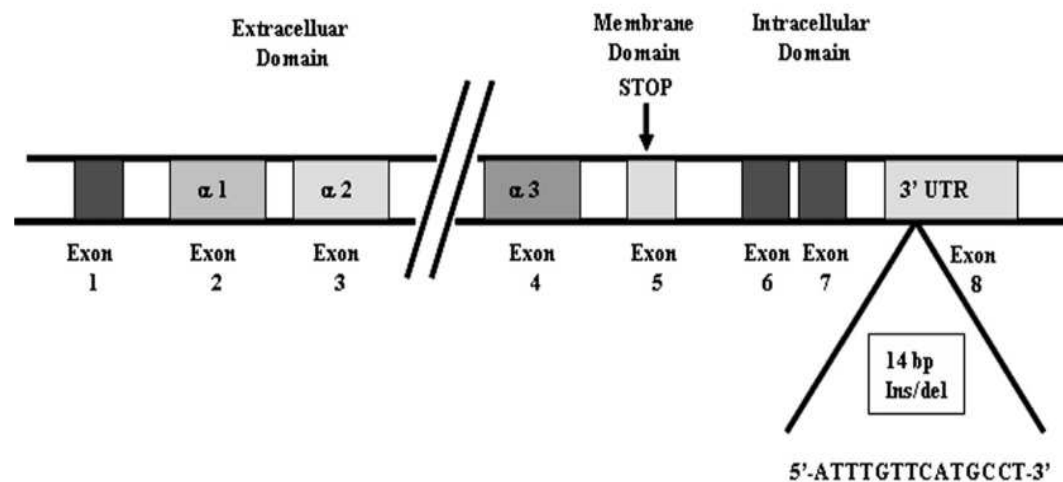

Fig. (2). Organization of the HLA-G gene. Axons and the corresponding protein domains are shown in detail. The nucleotide sequence of the 14 base pair (14bp) insertion/deletion polymorphism located in the 3' untranslated region of the exon 8 is shown.

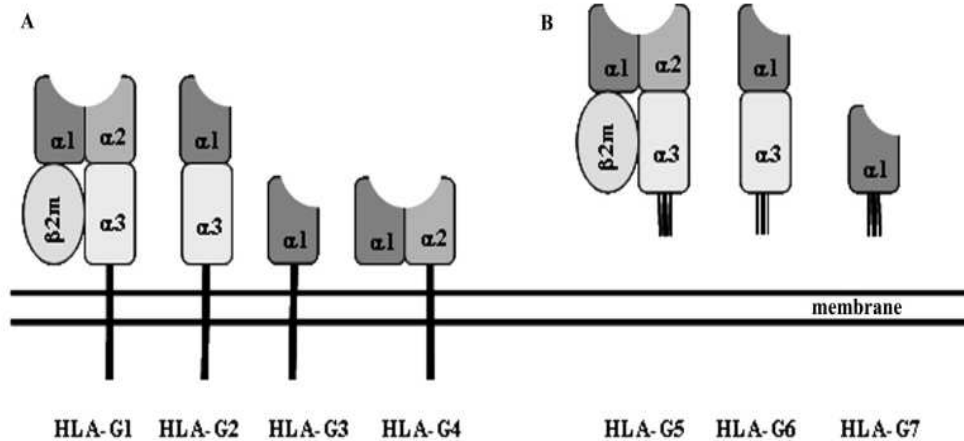

Fig. (3). HLA-G membrane-bound (A) and soluble (B) protein isoforms. HLA-G1 isoform is characterized by the  $\alpha 1$  and  $\alpha 2$ -domains that form the peptide-binding groove and by the  $\alpha 3$  domain that binds the  $\beta_2$  microglobulin. HLA-G2 isoform lacks the  $\alpha 2$ -domain; HLA-G4 isoform lacks the  $\alpha 3$ -domain while HLA-G3 isoform lacks both  $\alpha 2$  and  $\alpha 3$ -domains. HLA-G5, -G6 and -G7 isoforms resemble their corresponding membrane-bound HLA-G1, -G2 and -G3 isoforms but they lack the transmembrane domain.

FOXP3 negative regulatory T cell subpopulation with potent suppressive properties that are partially mediated by HLA-G.

A potential role for HLA-G molecules has been recently proposed in the cotransplantation of bone marrow mesenchymal stromal cells (MSCs) during allogeneic hematopoietic stem cell transplant. MSCs can counteract the graft-versus-host disease that represents the most frequent and severe complication in allogeneic hematopoietic stem cell transplantation. Although different mechanisms seem to be involved in the ability of MSCs to down-modulate the lymphoproliferative response to mitogen and alloantigens, three different reports have demonstrated the primary role of HLA-G molecules in this inhibitory function [34, 55-57].

Since the first report by Koller BH. in 1989 [58], about one thousand papers have analyzed the functional role of HLA-G molecules in pregnancy, cancer, viral infection, transplantation and autoimmune disease. This review will focus on the current knowledge on HLA-G modulation and susceptibility/maintenance of inflammatory condition.

#### HLA-G AND SKIN

The first observation on HLA-G expression in skin was reported by Aractingi in 2001 [59]. The authors identified the specific mRNAs for HLA-G1 and HLA-G5 isoforms in lesional skin specimens from psoriatic patients. Furthermore, using HLA-G specific monoclonal antibodies, they detected the presence of HLA-G molecules in the psoriatic sections but not in healthy subject samples. The presence of ITL2 natural killer receptor in psoriatic skin, as well as the detection of HLA-G antigens, proposed HLA-G modulation as a mechanism to counteract infiltrating T cells. In the same year Khosrotehrani [60] identified HLA-G antigen expression in biopsies from atopic dermatitis patients. In atopic dermatitis, such as in psoriasis, the presence of HLA-G positive cells in dermal infiltrates supports the hypothesis of an anti-inflammatory role of HLA-G antigens with a possible significant relevance in a favourable disease prognosis [61]. As previously reported, different studies have demonstrated the potential anti-inflammatory role of HLA-G 14bp polymor-

phism in regulating the quantitative production of HLA-G molecules [12, 62]. Gazit [63, 64] investigated the 14bp genotype distribution in Jewish patients affected by pemphigus vulgaris (PV) and in healthy subjects in order to analyze the possible association between 14bp genotypes and disease susceptibility. The comparison between the two groups demonstrated an increase of the deletion variant (-14bp) in PV patients. Consequently the authors proposed a relationship between HLA-G and disease due to the affection of NK and T cell cytotoxicity with a possible involvement in the immune response at the basis of this pathology. More recently Yari [65] confirmed, in PV, the modulation of HLA-G molecules at transcriptional and translational levels. In addition the patterns of HLA-G expression revealed a reduced HLA-G2 and an increased HLA-G1 transcription in epidermal cells of PV patients when compared to normal cells. Urošević [66] summarized the data obtained by several studies on HLA-G modulation in skin cancer and inflammatory dermatoses such as psoriasis and atopic dermatitis. Overall the author proposed a dual expression of HLA-G molecules in skin that mediates immunosuppression and cancer development or induces stimulatory mechanisms responsible for inflammatory skin diseases. However the real effect of HLA-G molecules on disease development is still unknown.

#### HLA-G AND NERVOUS SYSTEM

The HLA-G expression in the central nervous system (CNS) was firstly reported by Maier S. in 1999 [67]. The authors detected HLA-G transcripts in brain cells and in glioma cell lines, defining the relationship between HLA-G expression and cancer immune surveillance in CNS [68-70]. In 2007, Wiendl [71] reviewed the data on HLA-G expression in different neurological disorders with autoimmune, infectious, and neoplastic origins. HLA-G molecules seem to represent an inducible factor that could maintain an anti-inflammatory milieu in the CNS. The main paradigm of knowledge of HLA-G antigen tolerogenic role in CNS was obtained on Multiple Sclerosis (MS), the prototypic autoimmune inflammatory disorder of this anatomic district. In 2003 Fainardi [72], using a specific ELISA technique, re-

ported the first evidence of soluble HLA-G (sHLA-G) molecule presence in the cerebrospinal fluid (CSF) of MS patients. The results showed an increased HLA-G molecule mean level in the CSF of MS patients when compared to other inflammatory and non-inflammatory neurological disorders. Similarly, IL-10 cytokine, the main HLA-G up-modulator, presented higher levels in the CSF of MS patients. In a further paper the same authors demonstrated a link between intrathecal HLA-G synthesis and the magnetic resonance imaging (MRI) results of disease activity [73]. These data proposed a CSF-restricted release of sHLA-G during clinically stable MS confirming the anti-inflammatory functions of the HLA-G molecules and their protective role in counteracting the inflammatory conditions which characterize MS. These results suggested a balance between classical sHLA-I and non-classical sHLA-G products modulating both MRI and clinical disease activity in opposite directions. Fainardi [53] then identified the mainly produced sHLA-G isoform in CSF. The authors demonstrated the presence of HLA-G5 isoform in CSF of patients with relapsing-remitting multiple sclerosis. In a recent study [74], they showed an inverse association between CSF levels of soluble HLA-G and Fas molecules and the MRI evidence of disease activity. Considering the well known role of sHLA-G molecules in inducing CD8<sup>+</sup> and NK cells apoptosis [75], these results proposed a link between CSF sHLA-G levels and clinical conditions.

The cell types that can modulate HLA-G antigens in CNS of MS patients were investigated by Wiendl [76]. HLA-G immunoreactivity was observed in acute plaques, in chronic active plaques, in perilesional areas as well as in white matter normal appearance. In all these areas microglial cells, macrophages and part of the endothelial cells were identified as the primary cellular source of expression. These results propose a most complex relationship between HLA-G and MS development, maintenance and therapy. As known interferon-beta therapy represents one of the main therapeutic protocols in MS.

In 2005, a report by Mitsdoerffer [77] showed that the patients with relapsing remitting MS CD14<sup>+</sup> peripheral blood monocytes have significantly lower HLA-G expression in comparison with healthy control subjects. However both MS patients and healthy subjects showed a significant HLA-G up-modulation after "*in vitro*" stimulation with Interferon-beta (IFN-beta), the leading immune-modulatory agent used in MS treatment. The evaluation of HLA-G mRNA levels in the monocytes of MS patients confirmed a significant increase in HLA-G expression during IFN-beta therapy, suggesting a clinical role of these molecules in MS therapy.

The HLA-G expression was also analyzed in neural cells following viral infections [78] by rabies virus or herpes simplex virus type 1 [79]. The positive results reinforced the hypothesis of HLA-G modulation as an escape mechanism used by viruses against the cytotoxic CD8 positive and NK cell activities.

#### INFLAMMATORY MYOPATHIES

Wiendl H. and coauthors performed the analysis of HLA-G expression and role in inflammatory myopathies. They demonstrated the presence of HLA-G molecules in muscle

fibers of different inflammatory myopathies [80]. They showed the ability of HLA-G molecules to protect muscle cells from immuno-mediated lysis in an *in vitro* model of human myoblasts [81]. As HLA-G has an immunoinhibitory function due to its interaction with cellular cytotoxic immune effectors, this molecule represents an appealing self-derived anti-inflammatory factor. These characteristics could sustain its possible application in gene therapy, transplantation and inflammation control [82].

#### HLA-G AND GASTROINTESTINAL DISEASES

The relationship between inflammatory condition and HLA-G presence suggested the analysis of the expression of this molecule in gastrointestinal disease. A recent review by Down-Kelly [83] reported all the conflicting results obtained in this field that still fails to identify a precise link. However, three different studies investigated the HLA-G expression in ulcerative colitis (UC) and Crohn's disease (CD) focusing on its link with clinical condition and pathogenesis. In particular, in 2004 Torres [84] analyzed the expression of HLA-G molecules in intestinal biopsies of UC and CD patients. They demonstrated, by an immunohistochemistry approach, the presence of HLA-G molecules on the surface of intestinal epithelial cells of UC patients in spite of the complete absence in CD intestinal biopsies. In addition, high levels of IL-10 were detected in the lamina propria of the colon of patients with UC, supporting the hypothesis of a role of HLA-G in UC as a regulator of mucosal immune responses. A different pattern of HLA-G expression was suggested as a potential biological marker to distinguish these two diseases. Glas [85] analyzed the genotype distribution of the HLA-G 14bp polymorphism in UC and CD. The results showed an increase of both heterozygous +14/-14 bp and homozygous +14/+14 bp genotypes in UC patients, with a consequent decrease of the -14/-14bp condition when compared to CD subjects. A significant increase of the +14/+14bp genotype and a corresponding decrease of the -14/-14bp homozygous condition were observed in those CD cases positive for ileocecal resection. A further confirmation of a significant difference in HLA-G expression between CD and UC disease was recently obtained by Rizzo [86] that investigated the *in vitro* sHLA-G production by peripheral blood mononuclear cells (PBMCs) activated by an inflammatory stimulus such as LPS. The data demonstrated a spontaneous secretion of sHLA-G by non activated PBMCs of CD patients but not in UC and healthy subjects. A lack of sHLA-G antigen production was observed following LPS activation in UC patients but not in CD patients and healthy subjects. The defective production was related to a generalized impaired secretion of IL-10 in response to the inflammatory stimulus in UC disease. These different specific and reproducible patterns of sHLA-G production in UC and CD patients reinforced the hypothesis of a distinct etiopathogenesis mechanism among these disorders and proposed the analysis of sHLA-G and IL-10 anti-inflammatory molecules as a non invasive diagnostic tool in the early phases of the diseases. These data propose the study of the differences in immunological homeostasis between UC and CD diseases in order to understand the discrepancies between *in vivo* and *in vitro* results. It is clear that there is a complex immunological balance in UC and CD patients that differs in intestinal and systemic HLA-G production.

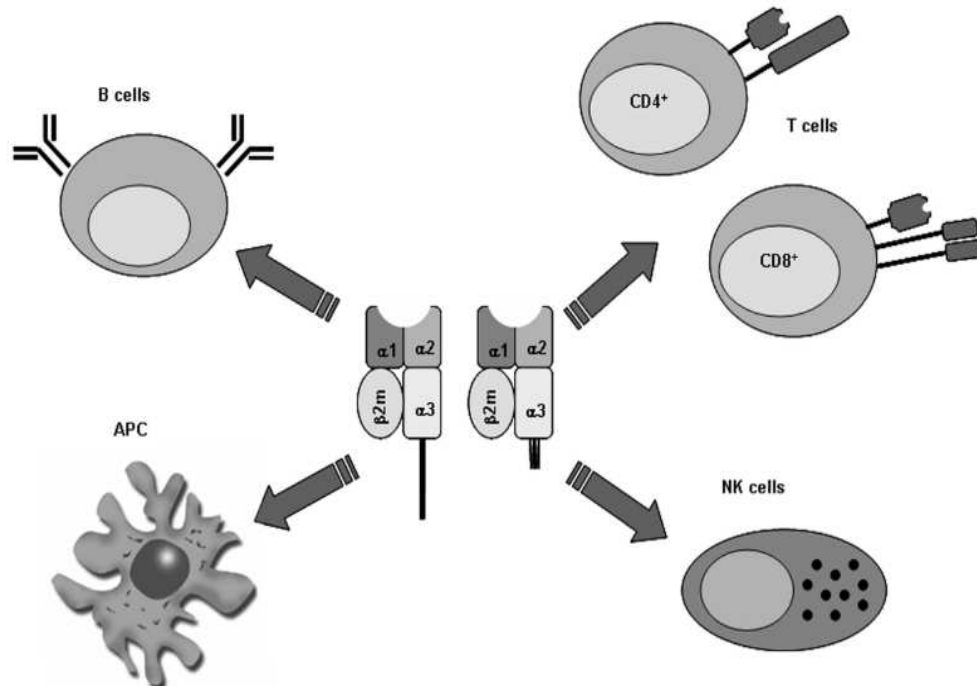

**Fig. (4). Immune cell targets of HLA-G molecules.** HLA-G antigen behaves as an anti-inflammatory and tolerogenic molecule inhibiting different immune cell phenotypes such as CD4<sup>+</sup> and CD8<sup>+</sup> T and B lymphocytes, natural killer (NK) and antigen presenting (APC) cells.

In 2006 Torres MI. and coauthors investigated the HLA-G modulation in coeliac disease and the possible relationship with clinical conditions [87]. They analyzed the expression of HLA-G molecules in intestinal biopsy and sHLA-G serum levels in patients with coeliac disease. All patients showed a positive HLA-G expression in intestinal mucosa and an increased serum concentration of sHLA-G molecules when compared to the healthy subject group. However, the detection of elevated levels of sHLA-G was demonstrated to be associated with the presence of other autoimmune diseases in celiac patients and/or related to diet transgressions with gluten ingestion.

#### HLA-G AND RHEUMATOID DISEASES

In 2006 a study by Verbruggen [88] reported a potential correlation between sHLA-G plasma concentration and the clinical conditions in rheumatoid arthritis (RA) patients. The results showed a decreased sHLA-G level in plasma specimens from RA patients when compared to healthy control subject samples. Since sHLA-G strongly inhibits T and NK cells functions, the authors suggested that the presence of low sHLA-G levels in rheumatoid arthritis disease could cause an inefficient inhibition of the cytotoxic cell activities. Soluble HLA-G levels were relatively higher in patients carrying the HLA-class II determinant HLA-DQB1\*03, that increases the disease susceptibility and is significantly correlated with disease activity or severity. These results supported the hypothesis of a functional role of HLA-G molecules in RA but were unable to explain the mechanisms that sustain the inflammatory condition. In the same year Rizzo [89] demonstrated a pharmacogenetic role of the HLA-G

14bp polymorphism in the clinical response of RA patients to Methotrexate (MTX), the principle therapy in the first phases of rheumatoid arthritis.

The authors evidenced, by an “*in vitro*” model, the ability of MTX to up-modulate IL-10 secretion that in turn leads to the production of sHLA-G molecules. They observed higher secretion of sHLA-G by the subjects with a -14/-14bp genotype, characterized by a stable mRNA. The analysis of HLA-G 14bp genotype distribution in a group of RA patients following a MTX therapy and clinically defined as responder /non responder to the treatment confirmed an increased frequency of the -14/-14bp genotype in the responder patient group suggesting the HLA-G 14bp polymorphism as a therapy marker in the early phases of the disease.

More recently Veit [90] investigated the distribution of HLA-G 14bp polymorphism in RA and juvenile idiopathic arthritis (JIA). They showed an increased frequency of the 14bp deleted allele, but no differences in the percentages of heterozygous or homozygous genotypes in JIA females. In contrast no significant differences were observed between healthy subjects and RA patients. These results sustain the role of HLA-G 14bp polymorphism in the pharmacogenetics of MTX therapy but not in the RA development. Even if JIA and RA share some common features, such as pro-inflammatory response with a consequent joint and tissue destruction, HLA-G 14bp polymorphism seems to show the discrepancies between these two diseases. The lower sHLA-G levels in RA patient serum samples [90] are still indicative that HLA-G molecule might play a role also in the physiopathology of RA and could propose the analysis of other HLA-

G gene polymorphisms in order to show a possible correlation to the disease.

Recently two papers pointed out the relationship between HLA-G modulation and Systemic Lupus Erythematosus disease (SLE). Rosado [91] observed elevated levels of sHLA-G and IL-10 cytokine in patient serum when compared to healthy subjects. A weak expression of HLA-G molecules was detected in patient skin biopsies without significant correlations with disease activity. Rizzo [54] confirmed the increase in IL-10 cytokine levels but, in contrast to Rosado S. results [91], proposed lower median concentrations of sHLA-G molecules in patient plasma samples. The analysis of the 14bp polymorphism in SLE patients showed an increased frequency of +14bp HLA-G allele and +14/+14bp genotype, characterized by mRNA instability, in comparison to healthy subjects. This result suggested a role of the HLA-G 14bp polymorphism in SLE susceptibility mediated by an inadequate production of the anti-inflammatory HLA-G molecules. The discrepancies in sHLA-G levels between these two studies could be ascribed to the different samples (serum or plasma) analyzed. Indeed Rudstein-Svetlicky [92] demonstrated that sHLA-G levels are higher in plasma than in serum obtained from the same subject because of a trapping phenomenon, during clot formation, able to subtract sHLA-G molecules from the serum.

#### HLA-G AND ASTHMA

The possible role of HLA-G molecules was also investigated in allergic diseases such as asthma. The first study was reported by Nicolae D. in 2005 [93]. The authors used a positional candidate gene study and proposed HLA-G as a novel asthma and bronchial hyperresponsiveness susceptibility gene. In a following paper by Tanz [94], the authors reported a SNP in the 3' untranslated region of HLA-G gene that could influence the targeting of three microRNAs to the gene, with a possible functional role in asthma susceptibility. The biological role of HLA-G molecules in asthma was demonstrated by Rizzo R. in 2005 [95]. The authors used PBMC from healthy and asthmatic subjects stimulated by LPS in an *in vitro* system. They showed a specific deficit in IL-10 secretion by asthmatic patients and a consequent reduced production of sHLA-G molecules. The decreased expression of HLA-G immunosuppressive molecules was suggested to contribute to the persistence of the chronic airway inflammation in asthma disease. However, a following study on asthmatic children [96] failed to find a significant difference in sHLA-G plasma levels when compared to healthy children. Higher levels of soluble HLA-G molecules were evidenced in atopic asthmatics with respect to controls. These data seem to be in contrast and this could be due to a different analytical approach. It has to be considered that the systemic production could be affected by drugs, atopy and external factors that are avoided in the *in vitro* system.

#### CONCLUSION

The results of the studies on HLA-G functions in inflammatory diseases confirm the double role of the HLA-G molecules previously suggested. It resembles the Janus of Roman mythology usually depicted with two faces looking in opposite directions. Similarly, the modulation of HLA-G molecules can induce conflicting clinical consequences in relation to the specific microenvironment. It is well accepted

that HLA-G expression represents a beneficial event in embryo implantation and organ transplantation, where the immune response down-regulation is essential for a positive outcome. On the other hand, HLA-G up-modulation is associated with negative events in cancer and viral infections, where the expression of these tolerogenic molecules could act as an immune-escape mechanism from the innate and adaptive immune response.

In inflammatory diseases, although some contrasting results in skin affection, the expression of HLA-G antigens is generally associated to a positive clinical condition. The ability of HLA-G molecules to counteract autoreactive T cells as well as to stimulate the proliferation of HLA-G positive regulatory T cells and induce a Th2 microenvironment represent the main functional benefits mediated by HLA-G molecules.

Therefore the setting-up of strategies able to up-regulate the expression of these natural anti-inflammatory molecules could represent a fundamental improvement in autoimmune diseases prevention and therapy.

#### ACKNOWLEDGEMENT

We thank Dr. Amanda Neville for writing assistance.

#### REFERENCES

- Aniel, J.C. Study of the leukocyte phenotypes in Hodgkin's disease. In *Histocompatibility testing*. Curtoni, E.S.; Mattiuz, P.L.; Tosi, R.M. Munksgaard Publishing: Copenhagen, 1967; p 69.
- Tiwari, J.L. and Terasaki, P.I. HLA and disease associations. Springer Publishing: Berlin, 1985.
- Thorsby, E. *Human Immunol.*, 1997, 53, 1.
- Lie, B.A.; Thorsby, E. *Curr Opin Immunol.*, 2005, 17, 526.
- Carosella, E.D.; Moreau, P.; LeMaout, J.; and Rouas-Freiss N. *Trends in Immunology*, 2008, 3, 125.
- <http://www.anthonynolan.org.uk/HIG/lists/class1list.html>, April 2008.
- Ishitani, A.; Geraghty, D.E. *Proc. Natl. Acad. Sci. USA*, 1992, 89, 3947.
- Park, G.M.; Lee, S.; Park, B.; Kim, E.; Shin, J.; Cho, K.; Ahn, K. *Biochem Biophys Res Commun*, 2004, 313, 606.
- Harrison, G.A.; Humphrey, K.E.; Jakobsen, I.B.; Cooper, D.W. *Hum. Mol. Genet.*, 1993, 2, 2200.
- Tamaki, J.; Arimura, Y.; Koda, T.; Fujimoto, S.; Fujino, T.; Wakisaka, A.; Kakinuma, M. *Microbiol Immunol*, 1993, 37, 633.
- Hviid, T.V.; Hylentius, S.; Rorbye, C.; Nielsen, L.G. *Immunogenetics*, 2003, 55, 63.
- Hviid, T.V.; Rizzo, R.; Christiansen, O.B.; Melchiorri, L.; Lindhard, A.; Baricordi, O.R. *Immunogenetics*, 2004, 56, 135.
- Rizzo, R.; Hviid, T.V.F.; Stignani, M.; Balboni, A.; Grappa, M.T.; Melchiorri, L. *Immunogenetics*, 2005, 57, 172.
- Ellis, S.A.; Palmer, M.S.; McMichael, A.J. *J. Immunol.* 1990, 144, 731.
- Rouas-Freiss, N.; Marchal, R.E.; Kirszenbaum, M.; Dausset, J.; Carosella, E.D. *Proc. Natl. Acad. Sci. U.S.A.* 1997, 94, 5249.
- Pazmany, L.; Mandelboim, O.; Valés-Gómez, M.; Davis, D.M.; Reyburn, H.T.; Strominger, J.L. *Science*, 1996, 274, 792.
- Rouas-Freiss, N.; Goncalves, R.M.; Menier, C.; Dausset, J.; Carosella, E.D. *Proc. Natl. Acad. Sci. USA*, 1997, 94, 11520.
- Khalil-Daher, I.; Riteau, B.; Menier, C.; Sedlik, C.; Paul, P.; Dausset, J.; Carosella, E.D.; Rouas-Freiss, N. *J. Reprod. Immunol.*, 1999, 43, 175.
- Riteau, B.; Rouas-Freiss, N.; Menier, C.; Paul, P.; Dausset, J.; Carosella, E.D. *J. Immunol.*, 2001, 166, 5018.
- Le Gal, F.A.; Riteau, B.; Sedlik, C.; Khalil-Daher, I.; Menier, C.; Dausset, J.; Guillet, J.C.; Carosella, E.D.; Rouas-Freiss, N. *Int. Immunol.*, 1999, 11, 1351.
- Fournel, S.; Aguerre-Girr, M.; Huc, X.; Lenfant, F.; Alam, A.; Toubert, A.; Bensussan, A.; Le Bouteiller, P. *J. Immunol.*, 2000, 164, 6100.



- [22] Riteau, B.; Menier, C.; Khalil-Daher, I.; Sedlik, C.; Dausset, J.; Rouas-Freiss, N.; Carosella, E.D. *J. Reprod. Immunol.*, 1999, 43, 203.
- [23] Bainbridge, D.R.; Ellis, S.A.; Sargent, I.L. HLA-G suppresses proliferation of CD4(+) T-lymphocytes. *J. Reprod. Immunol.*, 2000, 48, 17.
- [24] Lila, N.; Rouas-Freiss, N.; Dausset, J.; Carpentier, A.; Carosella, E.D. *Proc. Natl. Acad. Sci. USA*, 2001, 98, 12150.
- [25] Contini, P.; Ghio, M.; Merlo, A.; Poggi, A.; Indivieri, F.; Puppo, F. *J. Immunol.*, 2005, 157, 7244.
- [26] Onno, M.; Guillaudoux, T.; Amiot, L.; Renard, I.; Drenou, B.; Hirel, B.; Gurr, M.; Semana, G.; Le Bouteiller, P.; Fauchet, R. *Hum. Immunol.*, 1994, 41, 79.
- [27] Le Discorde, M.; Moreau, P.; Sabatier, P.; Legeais, J.M.; Carosella, E.D. *Hum. Immunol.*, 2003, 64, 1039.
- [28] Cirulli, V.; Zalatan, J.; McMaster, M.; Prinsen, R.; Salomon, D.R.; Ricordi, C.; Torbett, B.E.; Meda, P.; Crisa, L. *Diabetes*, 2006, 55, 1214.
- [29] Rebmann, V.; Pfeiffer, K.; Pässler, M.; Ferrone, S.; Maier, S.; Weiss, E.; Grosse-Wilde, H. *Tissue Antigens*, 1999, 53, 14.
- [30] Moreau, P.; Adrian-Cabestre, F.; Menier, C.; Guiard, V.; Gouraud, L.; Dausset, J.; Carosella, E.D.; Paul, P. *Int. Immunol.*, 1999, 11, 803.
- [31] Rizzo, R.; Melchiorri, L.; Stignani, M.; Baricordi, O.R. *Hum. Immunol.*, 2007, 68, 244.
- [32] Le Rond, S.; Azéma, C.; Krawiec-Radanne, I.; Durrbach, A.; Guettier, C.; Carosella, E.D.; Rouas-Freiss, N. *J. Immunol.*, 2006, 176, 3266.
- [33] Feger, U.; Tolosa, E.; Huang, Y.H.; Waschbisch, A.; Biedermann, T.; Melms, A.; Wiendl, H. *Blood*, 2007, 110, 568.
- [34] Selmani, Z.; Naji, A.; Zidi, I.; Favier, B.; Gaiffe, E.; Obert, L.; Borg, C.; Saas, P.; Tiberghien, P.; Rouas-Freiss, N.; Carosella, E.D.; Deschaseaux, F. *Stem Cells*, 2008, 26, 212.
- [35] Fons, P.; Chabot, S.; Cartwright, J.E.; Lenfant, F.; L'Faqih, F.; Giustiniani, J.; Herault, J.P.; Gueguen, G.; Bono, F.; Savi, P.; Aguerre-Girr, M.; Fournel, S.; Malecaze, F.; Bensussan, A.; Plouët, J.; Le Bouteiller, P. *Blood*, 2006, 108, 2608.
- [36] Le Bouteiller, P.; Fons, P.; Herault, J.P.; Bono, F.; Chabot, S.; Cartwright, J.E.; Bensussan, A. *J. Reprod. Immunol.*, 2007, 76, 17.
- [37] Hunt, J.S. *Immunol. Rev.*, 2006, 213, 36.
- [38] Hackmon, R.; Koffman, A.; Hyobo, H.; Glickman, H.; Sheiner, E.; Geraghty, D.E. *Am. J. Obstet. Gynecol.*, 2007, 197, 255.
- [39] Derrien, M.; Pizzato, N.; Dolcini, G.; Menu, E.; Chaouat, G.; Lenfant, F.; Barré-Sinoussi, F.; Bouteiller, P.L. *J. Gen. Virol.*, 2004, 85, 1945.
- [40] Matte, C.; Lajoie, J.; Lacaille, J.; Zijenah, L.S.; Ward, B.J.; Roger, M. *AIDS*, 2004, 18, 427.
- [41] Onno, M.; Pangault, C.; Le Fricq, G.; Guilloux, V.; André, P.; Fauchet, R. *J. Immunol.*, 2000, 164, 6426.
- [42] Donaghy, L.; Gros, F.; Amiot, L.; Mary, C.; Maillard, A.; Guiguen, C.; Gangneux, J.P. *Clin. Exp. Immunol.*, 2007, 147, 236.
- [43] Rouas-Freiss, N.; Moreau, P.; Menier, C.; LeMaoult, J.; Carosella, E.D. *Semin. Cancer Biol.*, 2007, 17, 413.
- [44] Pistoia, V.; Morandi, F.; Wang, X.; Ferrone, S. *Semin. Cancer Biol.*, 2007, 17, 469.
- [45] Crispim, J.C.; Duarte, R.A.; Soares, C.P.; Costa, R.; Silva, J.S.; Mendes-Junior, C.T.; Wastowski, I.J.; Faggioni, L.P.; Saber, L.T.; Donadi, E.A. *Transpl. Immunol.*, 2008, 18, 361.
- [46] Sebt, Y.; Le Mau, A.; Gros, F.; De Guibert, S.; Pangault, C.; Rouas-Freiss, N.; Bernard, M.; Amiot, L. *Br. J. Haematol.*, 2007, 138, 202.
- [47] Morandi, F.; Levrieri, I.; Bocca, P.; Galleni, B.; Raffaghello, L.; Ferrone, S.; Prigione, I.; Pistoia V. *Cancer Res.*, 2007, 67, 6433.
- [48] Urošević, M.; Dummer, R. *Cancer Res.*, 2008, 68, 627.
- [49] Lila, N.; Carpentier, A.; Amrein, C.; Khalil-Daher, I.; Dausset, J.; Carosella, E.D. *Lancet*, 2000, 355, 2138.
- [50] Lila, N.; Amrein, C.; Guillemain, R.; Chavalier, P.; Latrempuille, C.; Fabiani, J.N.; Dausset, J.; Carosella, E.D.; Carpentier, A. *Circulation*, 2002, 105, 1949.
- [51] Qiu, J.; Terasaki, P.I.; Miller, J.; Mizutani, K.; Cai, J.; Carosella, E.D. *Am. J. Transplant.*, 2006, 6, 2152.
- [52] Luque, J.; Torres, M.I.; Aumente, M.D.; Marin, J.; Garcia-Jurado, G.; Gonzales, R.; Pascual, D.; Guerra, N.; Lopez-Rubio, F.; Alvarez, M.R.; Arizon, J.M.; Pena, J. *Hum. Immunol.*, 2006, 67, 257.
- [53] Fainardi, E.; Rizzo, R.; Melchiorri, L.; Stignani, M.; Castellazzi, M.; Caniatti, M.L.; Baldi, E.; Tola, M.R.; Granieri, E.; Baricordi, O.R. *J. Neuroimmunol.*, 2007, 192, 219.
- [54] Rizzo, R.; Hviid, T.V.F.; Govoni, M.; Padovan, M.; Rubini, M.; Melchiorri, L.; Stignani, M.; Carturan, S.; Grappa, M.T.; Fotinidi, M.; Ferretti, S.; Voss, A.; Lastrup, H.; Junker, P.; Trotta, F.; Baricordi, O.R. *Tissue Antigens*, 2008 in press.
- [55] Nasef, A.; Mathieu, N.; Chapel, A., et al. *Transplantation*, 2007, 84, 231.
- [56] Naji, A.; Le Rond, S.; Durrbach, A.; Krawiec-Radanne, I.; Creput, C.; Daouya, M.; Caumarin, J.; LeMaoult, J.; Carosella, E.D.; Rouas-Freiss, N. *Blood*, 2007, 110, 3936.
- [57] Rizzo, R.; Campioni, D.; Stignani, M.; Melchiorri, L.; Bagnara, G.P.; Bonsi, L.; Alviano, F.; Lanzoni, G.; Moretti, S.; Cuneo, A.; Lanza, F. and Baricordi, O.R. *Cytotherapy*, 2008, in press.
- [58] Koller, B.H.; Geraghty, D.E.; DeMars, R.; Duvick, L.; Rich, S.S.; Orr, H.T. *J. Exp. Med.*, 1989, 169, 469.
- [59] Aractingi, S.; Briand, N.; Le Danff, C.; Viguier, M.; Bachelez, H.; Michel, L.; Dubertret, L.; Carosella, E.D. *Am. J. Pathol.*, 2001, 159, 71.
- [60] Khosrotehrani, K.; Le Danff, C.; Reynaud-Mendel, B.; Dubertret, L.; Carosella, E.D.; Aractingi, S. *J. Invest. Dermatol.*, 2001, 117, 750.
- [61] Carosella, E.D.; Moreau, P.; Aractingi, S.; Rouas-Freiss, N. *Trends Immunol.*, 2001, 22, 553.
- [62] Hviid, T.V.F.; Rizzo, R.; Melchiorri, L.; Stignani, M.; Baricordi, O.R. *Hum. Immunol.*, 2006, 67, 53.
- [63] Gazit, E.; Slomov, Y.; Goldberg, I.; Brenner, S.; Loewenthal, R. *Hum. Immunol.*, 2004, 65, 39.
- [64] Gazit, E.; Loewenthal, R. *Autoimmun. Rev.*, 2005, 4, 16.
- [65] Yari, F.; Zavarani Hosseini, A.; Nemat Gorgani, M.; Khorramizadeh, M.R.; Mansouri, P.; Kazemnejad, A. *Iran J. Allergy Asthma Immunol.*, 2008, 7, 7.
- [66] Urošević, M. *Seminars in cancer biology*, 2007, 17, 480.
- [67] Maier, S.; Geraghty, D.E.; Weiss, E.H. *Transplant., Proc.*, 1999, 31, 1849.
- [68] Wiendl, H.; Mitsdoerffer, M.; Hofmeister, V.; Wischhusen, J.; Bornemann, A.; Meyermann, R.; Weiss, E.H.; Melms, A.; Weller, M. *J. Immunol.*, 2002, 168, 4772.
- [69] Wiendl, H.; Mitsdoerffer, M.; Weller, M. *Semin. Cancer Biol.*, 2003, 13, 343.
- [70] Friese, M.A.; Steinle, A.; Weller, M. *Onkologie*, 2004, 27, 487.
- [71] Wiendl, H. *Hum. Immunol.*, 2007, 68, 286.
- [72] Fainardi, E.; Rizzo, R.; Melchiorri, L.; Vaghi, L.; Castellazzi, M.; Marzola, A.; Govoni, V.; Paolino, E.; Tola, M.R.; Granieri, E.; Baricordi, O.R. *J. Neuroimmunol.*, 2003, 142, 149.
- [73] Fainardi, E.; Rizzo, R.; Melchiorri, L.; Castellazzi, M.; Paolino, E.; Tola, M.R.; Granieri, E.; Baricordi, O.R. *Mult. Scler.*, 2006, 12, 2.
- [74] Fainardi, E.; Rizzo, R.; Melchiorri, L.; Stignani, M.; Castellazzi, M.; Tamborino, C.; Paolino, E.; Tola, M.R.; Granieri, E.; Baricordi, O.R. *Mult. Scler.*, 2008 in press.
- [75] Contini, P.; Ghio, M.; Poggi, A.; Filici, G.; Indivieri, F.; Ferrone, S.; Puppo, F. *Eur. J. Immunol.*, 2003, 33, 125.
- [76] Wiendl, H.; Feger, U.; Mittelbronn, M.; Jack, C.; Schreiner, B.; Stadelmann, C.; Antel, J.; Brueck, W.; Meyermann, R.; Bar-Or, A.; Kieseier, B.C.; Weller, M. *Brain*, 2005, 128, 2689.
- [77] Mitsdoerffer, M.; Schreiner, B.; Kieseier, B.C.; Neuhaus, O.; Dichgans, J.; Hartung, H.P.; Weller, M.; Wiendl, H. *J. Neuroimmunol.*, 2005, 159, 155.
- [78] Lafon, M.; Prehaud, C.; Megret, F.; Lafage, M.; Mouillot, G.; Roa, M.; Moreau, P.; Rouas-Freiss, N.; Carosella, E.D. *J. Virol.*, 2005, 79, 15226.
- [79] Megret, F.; Prehaud, C.; Lafage, M.; Moreau, P.; Rouas-Freiss, N.; Carosella, E.D.; Lafon, M. *Hum. Immunol.*, 2007, 68, 294.
- [80] Wiendl, H.; Behrens, L.; Maier, S.; Johnson, M.A.; Weiss, E.H.; Hohlfeld, R. *Ann. Neurol.*, 2000, 48, 679.
- [81] Wiendl, H.; Mitsdoerffer, M.; Hofmeister, V.; Wischhusen, J.; Weiss, E.H.; Dichgans, J.; Lochmüller, H.; Hohlfeld, R.; Melms, A.; Weller, M. *Brain*, 2003, 126, 176.
- [82] Wiendl, H.; Mitsdoerffer, M.; Weller, M. *Hum. Immunol.*, 2003, 64, 1050.
- [83] Downs-Kelly, E.; Schade, A.E.; Hansel, D.E. *Semin. Cancer Biol.*, 2007, 17, 451.
- [84] Torres, M.I.; Le Discorde, M.; Lorite, P.; Rios, A.; Gassull, M.A.; Gil, A.; Maldonado, J.; Dausset, J.; Carosella, E.D. *Int. Immunol.*, 2004, 16, 579.

- [85] Glas, J.; Török, H.P.; Tonenchi, L.; Wetzke, M.; Beynon, V.; Teshome, M.Y.; Cotofana, S.; Schiemann, U.; Griga, T.; Klein, W.; Epplen, J.T.; Folwaczny, C.; Folwaczny, M.; Mussack, T.; Weiss, E.H. *Int. Immunol.*, **2007**, *19*, 621.
- [86] Rizzo, R.; Melchiorri, L.; Simone, L.; Stignani, M.; Marzola, A.; Gullini, S.; Baricordi, O.R. *Inflamm. Bowel Dis.*, **2008**, *14*, 100.
- [87] Torres, M.I.; López-Casado, M.A.; Luque, J.; Peña, J.; Rios, A. *Int. Immunol.*, **2006**, *18*, 713.
- [88] Verbruggen, L.A.; Rebmann, V.; Demanet, C.; De Cock, S.; Grosse-Wilde, H. *Hum. Immunol.*, **2006**, *67*, 561.
- [89] Rizzo, R.; Rubini, M.; Govoni, M.; Padovan, M.; Melchiorri, L.; Stignani, M.; Carturan, S.; Ferretti, S.; Trotta, F.; Baricordi, O.R. *Pharmacogenet. Genomics*, **2006**, *16*, 615.
- [90] Veit, T.D.; Vianna, P.; Scheibel, I.; Brenol, C.; Brenol, J.C.; Xavier, R.M.; Delgado-Cañedo, A.; Gutierrez, J.E.; Brandalize, A.P.; Schuler-Faccini, L.; Chies, J.A. *Tissue Antigens*, **2008** in press.
- [91] Rosado, S.; Perez-Chacon, G.; Mellor-Pita, S.; Sanchez-Vegazo, I.; Bellas-Mendez, C.; Citores, M.J.; Losada-Fernandez, I.; Martin-Donaire, T.; Rebollada, N.; Perez-Aciego, P. *Hum. Immunol.*, **2008**, *69*, 9.
- [92] Rudstein-Svetlicky, N.; Loewenthal, R.; Horejsi, V.; Gazit, E. *Tissue Antigens*, **2007**, *1*, 140.
- [93] Nicolae, D.; Cox, N.J.; Lester, L.A.; Schneider, D.; Tan, Z.; Billstrand, C.; Kuldane, S.; Donfack, J.; Kogut, P.; Patel, N.M.; Goodenbour, J.; Howard, T.; Wolf, R.; Koppelman, G.H.; White, S.R.; Parry, R.; Postma, D.S.; Meyers, D.; Bleecker, E.R.; Hunt, J.S.; Solway, J.; Ober, C. *Am. J. Hum. Genet.*, **2005**, *76*, 349.
- [94] Tan, Z.; Randall, G.; Fan, J.; Camoretti-Mercado, B.; Brockman-Schneider, R.; Pan, L.; Solway, J.; Gern, J.E.; Lemanske, R.F.; Nicolae, D.; Ober, C. *Am. J. Hum. Genet.*, **2007**, *81*, 829.
- [95] Rizzo, R.; Mapp, C.E.; Melchiorri, L.; Maestrelli, P.; Visentin, A.; Ferretti, S.; Bononi, I.; Miotto, D.; Baricordi, O.R. *J. Allergy Clin. Immunol.*, **2005**, *115*, 508.
- [96] Tahan, F.; Patiroglu, T. *Int. Arch. Allergy Immunol.*, **2006**, *141*, 213.

Received: April 22, 2008

Revised: May 9, 2008

Accepted: June 9, 2008

# Release of sICAM-1 in Oocytes and *In Vitro* Fertilized Human Embryos

Monica Borgatti<sup>1,3</sup>, Roberta Rizzo<sup>2,3</sup>, Maria Beatrice Dal Canto<sup>3</sup>, Daniela Fumagalli<sup>3</sup>, Mario Mignini Renzini<sup>3</sup>, Rubens Fadini<sup>3</sup>, Marina Stignani<sup>2</sup>, Olavio Roberto Baricordi<sup>2\*</sup>, Roberto Gambari<sup>1,4\*</sup>

**1** BioPharmaNet, Department of Biochemistry and Molecular Biology, University of Ferrara, Ferrara, Italy, **2** Department of Experimental and Diagnostic Medicine, Laboratory of Immunogenetics, University of Ferrara, Ferrara, Italy, **3** BIOGENESI Reproductive Medicine Centre, Istituti Clinici Zucchi, Monza, Italy, **4** Biotechnology Center, University of Ferrara, Ferrara, Italy

## Abstract

**Background:** During the last years, several studies have reported the significant relationship between the production of soluble HLA-G molecules (sHLA-G) by 48–72 hours early embryos and an increased implantation rate in IVF protocols. As consequence, the detection of HLA-G modulation was suggested as a marker to identify the best embryos to be transferred. On the opposite, no suitable markers are available for the oocyte selection.

**Methodology/Principal Findings:** The major finding of the present paper is that the release of ICAM-1 might be predictive of oocyte maturation. The results obtained are confirmed using three independent methodologies, such as ELISA, Bio-Plex assay and Western blotting. The sICAM-1 release is very high in immature oocytes, decrease in mature oocytes and become even lower in *in vitro* fertilized embryos. No significant differences were observed in the levels of sICAM-1 release between immature oocytes with different morphological characteristics. On the contrary, when the mature oocytes were subdivided accordingly to morphological criteria, the mean sICAM-1 levels in grade 1 oocytes were significantly decreased when compared to grade 2 and 3 oocytes.

**Conclusions/Significance:** The reduction of the number of fertilized oocytes and transferred embryos represents the main target of assisted reproductive medicine. We propose sICAM-1 as a biochemical marker for oocyte maturation and grading, with a possible interesting rebound in assisted reproduction techniques.

**Citation:** Borgatti M, Rizzo R, Canto MBD, Fumagalli D, Renzini MM, et al. (2008) Release of sICAM-1 in Oocytes and *In Vitro* Fertilized Human Embryos. PLoS ONE 3(12): e3970. doi:10.1371/journal.pone.0003970

**Editor:** Samuel Kim, University of Kansas Medical Center, United States of America

**Received:** August 6, 2008; **Accepted:** November 6, 2008; **Published:** December 18, 2008

**Copyright:** © 2008 Borgatti et al. This is an open-access article distributed under the terms of the Creative Commons Attribution License, which permits unrestricted use, distribution, and reproduction in any medium, provided the original author and source are credited.

**Funding:** R.G. is granted by Fondazione Cariparo (Cassa di Risparmio di Padova e Rovigo), CIB, by UE ITHANET Project (eInfrastructure for the Thalassemia Research Network) and by Telethon (contract GGP07257). This research is also supported by Regione Emilia-Romagna (Spinner Project) and by Associazione Veneta per la Lotta alla Talassemia (AVLT), Rovigo. The funders had no role in study design, data collection and analysis, decision to publish, or preparation of the manuscript.

**Competing Interests:** The authors have declared that no competing interests exist.

\* E-mail: bri@unife.it (ORB); gam@unife.it (RG)

☛ These authors contributed equally to this work.

## Introduction

Successful embryo formation and implantation are critical steps during *in vitro* fertilization procedure. Unfortunately, approximately 10% of retrieved oocytes and fewer than 20% of transferred embryos result in a successful delivery [1]. Analysis of the embryo morphology is still one of the most common approaches of selection in assisted reproduction, with the obvious drawback of being to some extent subjective.

Accordingly, there is urgent need of biochemical markers facilitating the prediction of successful oocyte fertilization and implantation of the *in vitro* fertilized (IVF) human embryos. In this respect, the only biochemical marker so far proposed for the selection of the most promising embryo obtained by IVF is represented by the release of *in vitro* cultured embryo (24-, 48- and 72-hours embryo) of soluble HLA-G (Histocompatibility Leukocyte Antigen-G) molecules. This has been consistently reported by several groups [2–7]. Using Enzyme-Linked Immunosorbent

Assay (ELISA) and Bio-plex approaches, these groups reported that high expression of soluble HLA-G is associated with higher pregnancy and implantation rates.

On the other hand the analysis of oocyte maturation might be of great importance in predicting successful fertilization and embryo development. As far as oocyte morphological criteria, several have been claimed to correlate with outcome, including polar body morphology [8]; cytoplasm appearance [9], and more recently zona pellucida thickness, appearance and birefringence [10–12] and the position or shape of the spindle [13]. Also in this case biochemical markers helping in identifying oocytes completing *in vitro* maturation would be very interesting in IVF approaches. Markers of oocyte maturation are the presence of activated mitochondria and the ability to mobilize and release calcium for internal stores [14].

In this paper we analyze the release by oocytes and *in vitro* fertilized human embryos of proteins involved in inflammation, including several cytokines, chemokines and soluble Interleukin

Adhesion Molecule 1 (sICAM-1). This study was carried on using three independent methodologies, such as ELISA, Bio-Plex assay [15,16], and Western blotting.

## Results

### Release of cytokines, chemokines and ICAM-1 by human embryos

We first performed a preliminary screening of 11 embryos using premixed multiplex beads of the Human 27-Plex Panel and the ICAM-1 Bio-Plex kit, obtaining the following results. IL-1 $\beta$ , IL-2, IL-4, IL-5, IL-10, IL-12 (P70), IL-15, IL-17, Basic FGF, G-CSF, GM-CSF, IFN- $\gamma$ , MIP-1 $\alpha$ , TNF- $\alpha$  were not present or undetectable in the analyzed supernatants. Presence of IL-1 $\alpha$ , IL-6, IL-7, IL-8, IL-9, IL-13, Eotaxin, IP-10, MCP-1 (MCAF), MIP-1 $\beta$ , PDGF-BB, RANTES, VEGF, ICAM-1 were detectable in 11, 1, 1, 10, 1, 1, 7, 1, 1, 1, 1, 4, 11 embryos respectively. The only proteins present in the supernatant of all the screened embryos were ICAM-1 and IL-1 $\alpha$ . However, only ICAM-1 was expressed at high levels. In additional experiments on other IVS embryos (not included in this paper) we never found absence of ICAM-1 release, with the exception of few damaged embryos (data not shown).

### Quantization of sICAM-1: ELISA and Bio-Plex assay

In Figure 1 representative analysis is shown demonstrating that levels of ICAM-1 standards are detectable following both ELISA and the Bio-Plex assay. As expected, however, the Bio-Plex assay is more sensitive than ELISA. This is of course important for analysis of single cells, including oocytes. Accordingly, Bio-Plex analysis was chosen for studies involving human oocytes and fertilized embryos.

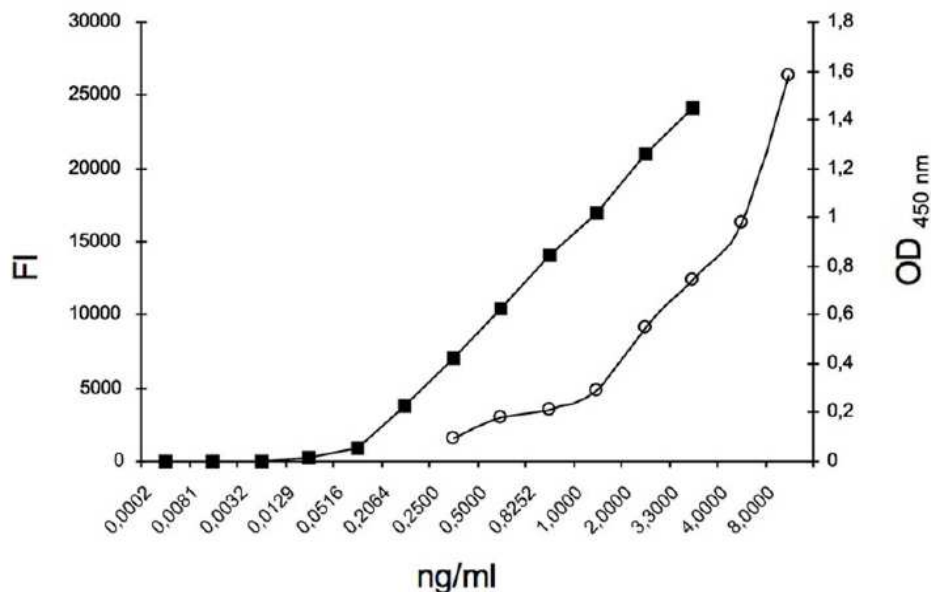

**Figure 1.** ELISA and Bio-Plex standard curves (white circles and black square respectively) have been obtained with 50  $\mu$ l of ICAM-1 standard reagent at the concentrations of 0.25, 0.5, 1, 2, 4, 8 ng/ml or 0.0002, 0.00081, 0.0032, 0.0129, 0.0516, 0.20638, 0.82522, 3.3 ng/ml as indicated. FI: fluorescence intensity values. OD 450 nm: optic density at 450 nm wavelength.  
doi:10.1371/journal.pone.0003970.g001

### Comparison of sICAM-1 production in mature and immature oocytes and in vitro fertilized embryos

Figure 2 reports a sharp difference in sICAM-1 levels among immature and mature oocytes and fertilized embryos. The average sICAM-1 production by immature ( $n=39$ ) and mature ( $n=73$ ) oocytes was  $6711.5 \pm 1502.4$  and  $2987 \pm 103.7$  pg/ml/24 hours (mean  $\pm$  SD), respectively (Figure 2). This difference was very reproducible and statistically significant (Student *t* Test,  $p < 0.0001$ ). In addition, the levels of release of sICAM-1 levels by mature oocytes and in vitro fertilized embryos ( $n=73$ ),  $1486.8 \pm 164.2$  pg/ml/24 hours, were also found to be significantly different (Student *t* Test,  $p < 0.0001$ ) (Figure 2). Therefore, it appears that the release of sICAM-1 has a clear tendency to decrease from immature embryos, to mature embryos and to fertilized embryos.

The presence of sICAM-1 molecules in oocytes culture supernatants was also analyzed by western blotting. The results obtained are shown in Figure 3. Standard positive ICAM-1 controls are shown in lanes "a" and "b". As clearly evident, sICAM-1 is detectable both in mature (lane "d") and immature (lane "c") oocyte supernatants. In addition, sICAM-1 is present in mature oocytes in lower quantities in respect to immature oocytes, fully in agreement with the Bio-Plex data shown in Figure 3. These data were fully in agreement with ELISA assays (data not shown).

### Production of sICAM-1 in immature and mature oocytes

Figure 4a reports the levels of sICAM-1 in immature oocytes at different maturation stages (MI, Metaphase I; GV, germinal vesicle; DEG, degenerated). The average released sICAM-1 was 5900 pg/ml/24 hours for MI oocytes, 6600 pg/ml/24 hours for GV oocytes and 6600 pg/ml/24 hour for DEG oocytes. The difference between sICAM-1 production by MI, GV and DEG

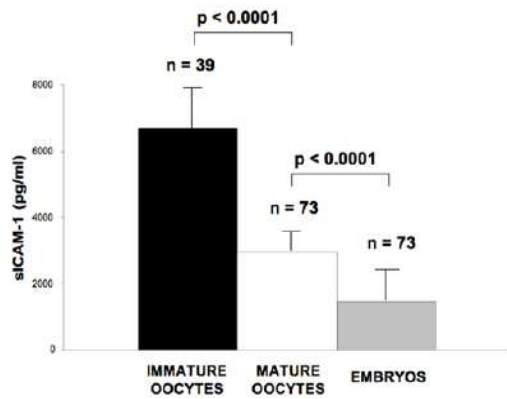

**Figure 2. sICAM-1 release in immature oocytes (black box) compared to mature (white box) oocytes and to in vitro fertilized embryo (grey box).** Oocytes were individually cultured in a 4-well culture dish as reported in the methods section. Following the maturation period 250  $\mu$ l of supernatants were collected from each culture system and stored at  $-20^{\circ}\text{C}$  until being tested for the presence released proteins. Mature and immature oocytes were identified, one by one, evaluating the presence or absence of the first polar body. In vitro fertilized embryos were individually cultured in 4-well culture dishes and 250  $\mu$ l of supernatants collected from each embryo culture and stored at  $-20^{\circ}\text{C}$  until being tested for the presence of released proteins. \* Student t Test. doi:10.1371/journal.pone.0003970.g002

immature oocytes was not statistically significant (Student t Test,  $p = \text{NS}$ ) (Figure 3a).

Moreover, Figure 4b reports the analysis of ICAM-1 release in mature oocytes subdivided in grade 1, 2 and 3, as reported in the material and methods section. The average released sICAM-1 was 2804 pg/ml/24 hours for grade 1 oocytes, 2978 pg/ml/24 hours for grade 2 oocytes and 2923 pg/ml/24 hours for grade 3 oocytes (Figure 4b). Statistical analysis showed significant lower levels of sICAM-1 in grade 1 oocyte supernatants in comparison to grade 2 (Student t Test,  $p = 0.018$ ) and grade 3 ( $p = 0.02$ ) oocyte supernatants. Therefore, lower sICAM-1 levels in mature oocyte are predictive for the best grade oocytes (Grade 1).

**sICAM-1 levels and Embryo Grade**

Figure 5 represents sICAM-1 levels in embryo culture supernatants graded as reported in the Methods section. The average levels of sICAM-1 were 1476.3  $\pm$  187 pg/ml/24 hours in the 29 Grade 1 embryos; 1522.4  $\pm$  206 pg/ml/24 hours in the 13 of Grade 2; 1481  $\pm$  116 pg/ml/24 hours in the 15 of Grade 3; 1461.9  $\pm$  143.9 pg/ml/24 hours in the 16 Grade 4 and 5 embryos.

The differences between sICAM-1 production by Grade 1, 2, 3, 4 and 5 embryos were not statistically significant (Student t Test,  $p = \text{NS}$ ).

**sICAM-1 levels in oocyte supernatants and pregnancy rate**

Table 1 reports the sICAM-1 mean levels observed in mature oocyte and embryo culture supernatants subdivided for implantation and pregnancy outcome.

There were no statistical differences (Student t Test,  $p = \text{NS}$ ) in sICAM-1 levels observed in the supernatant of oocytes and embryo with a negative or positive implantation and pregnancy rate (Table 1).

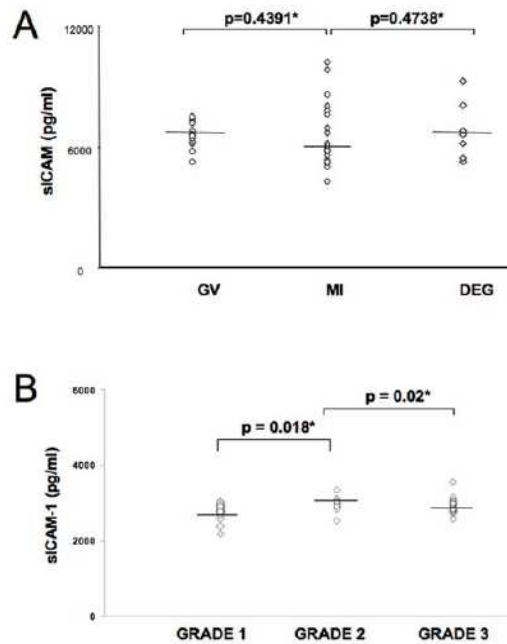

**Figure 3. Western blotting analysis.** The anti-ICAM-1 MoAb was used for the detection. a: standard positive control loaded at 8000 pg; b: plasma sample loaded at 10000 pg, accordingly to ELISA detection; c: medium negative control; d: mature oocyte supernatant loaded at 35 pg accordingly to ELISA detection; e: immature oocyte supernatant loaded at 100 pg accordingly to ELISA detection; M: protein ladder. doi:10.1371/journal.pone.0003970.g003

The relationship between oocyte grade (Figure 4b) and implantation/pregnancy rate was not investigated, since we were not able to associate the pregnancy event to a specific embryo. In fact, our IVF protocol, in order to achieve the highest probability of pregnancy and meet law restrictions [17], allows the transfer of three embryos that could originate from different grade oocytes.

**Comparison of sICAM-1 and sHLA-G levels in supernatants of oocytes using Bio-plex technology**

Since the release of soluble HLA-G (sHLA-G) molecules by in vitro fertilized embryos seems to help the morphological characterization in the selection of the most promising embryo obtained by IVF and has been proposed as a possible candidate marker for oocyte maturation [17] we compared the release of these two proteins in our samples. Representative analyses are shown in Figure 6, which clearly indicate that in human oocytes the release of sICAM-1 is far more efficient than release of sHLA-G molecules. In general, the release of sHLA-G molecules is very low in most of the oocytes employed. On the contrary, confident results are obtained studying sICAM-1, due to the high release of this protein by human oocytes.

**Discussion**

The reduction of the number of fertilized oocytes and transferred embryos represents the main target of assisted reproductive medicine. During the last years, several studies have

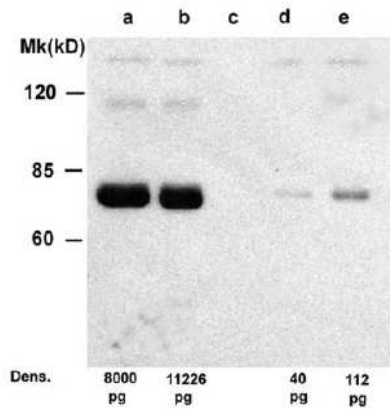

Figure 4

**Figure 4. sICAM-1 levels in culture supernatants from immature (a) and mature oocytes (b).** Immature oocytes were analysed individually for morphological characteristics to differentiate them as Metaphase I (MI), germinal vesicle (GV) and degenerated (DEG). (a). Mature oocytes were subdivided on the basis of the first polar body and cytoplasm characteristic in Grade 1, 2 and 3 (b). Preparation of oocyte supernatants was performed as described in the legend to Figure 2. \* Student t Test. doi:10.1371/journal.pone.0003970.g004

confirmed the significant relationship between the production of sHLA-G molecules by 48–72 hours early embryos and an increased implantation rate in IVF protocols [18]. As consequence, the detection of HLA-G modulation was suggested as a

marker to identify the best embryos to be transferred. On the opposite, no suitable markers are available for the oocyte selection. The major finding of this paper is the detection, by a reliable technique, of soluble ICAM-1 molecules in the culture supernatants of human in vitro matured oocytes and in vitro fertilized embryos. The data obtained showed a significant difference in sICAM-1 levels between immature and mature oocytes with significant higher amounts of sICAM-1 in the oocytes that failed to mature. When the immature oocytes were morphologically classified in metaphase I, germinal vesicle and degenerated phenotypes we observed similar levels of sICAM-1 in the three groups. On the contrary, the mature oocytes subdivided into grade 1, 2 and 3 presented lower s-ICAM-1 levels in grade 1 group. Therefore, these results propose sICAM-1 levels as predictive for oocyte maturation and quality. Biochemical markers of the oocyte maturation are very important, due to the fact that (a) during in vitro oocyte maturation no more than 50% of the oocytes isolated from a single woman reach grade 1 (Table 2); (b) only these oocytes are routinely considered for IVF. In addition, we like to point out that in some countries no embryo selection is allowed, only a limited number of oocytes are fertilized and all of the obtained embryos must be implanted [19].

The culture supernatants of early embryos showed sICAM-1 levels lower in comparison to both mature and immature oocytes. Interestingly no significant differences were observed in sICAM-1 concentrations in the culture supernatants of early embryos subdivided into grades. These results underline the importance of sICAM-1 as a marker of the oocyte maturation process but not of the early embryos development.

This is the first report showing release of sICAM-1 in human oocytes and IVF human embryo. However the expression of ICAM-1 in human embryos is not surprising, when considering the implantation phase. In this context, ICAM-1 has been already presented as a protein involved in inflammation. In fact ICAM-1 knock-out mice do not develop inflammation and have less

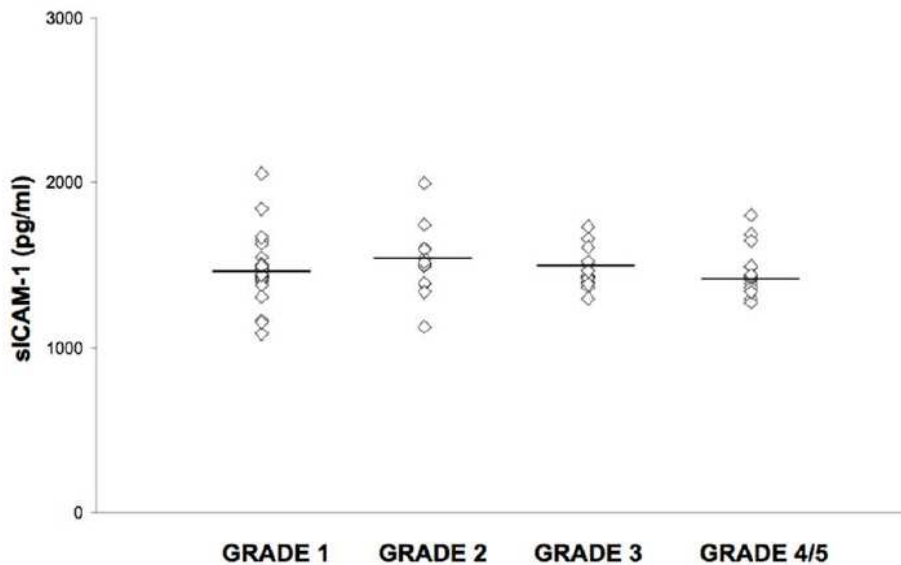

**Figure 5. sICAM-1 levels in embryo culture supernatants subdivided into grades as reported in the Methods section.** doi:10.1371/journal.pone.0003970.g005

**Table 1.** sICAM-1 release, implantation outcome and pregnancy outcome.

	Implantation outcome		Pregnancy outcome	
	positive	negative	positive	negative
frequency (n)	7	35	4	38
sICAM-1 oocytes (pg/ml)	2865.4±107.7	2856.9±520	2858.4±117.6	2860.7±403.1
sICAM-1 embryos (pg/ml)	1424.1±142.5	1493.8±170.7	1463.5±127.5	1483.9±171.2

doi:10.1371/journal.pone.0003970.t001

inflammatory cell infiltration [20,21]. Mutations of ICAM-1 are associated with different diseases as infarct, biliary atresia, multiple sclerosis, obesity [21–24]. When the sICAM-1 levels are compared to sHLA-G, a soluble molecule involved in embryo implantation [3], sICAM-1 showed higher levels in oocyte supernatants than sHLA-G. These two molecules are both secreted by human oocytes but with a more efficient release of sICAM-1 than of sHLA-G molecules. In general, the release of sHLA-G molecules is very low in most of the oocytes employed. On the contrary, confident results are obtained studying sICAM-1, due to the high release of this protein by human oocytes.

The results obtained are confirmed using three independent methodologies, such as ELISA, Bio-Plex assay and Western blotting. Therefore, we propose this biochemical marker to be tightly linked to oocyte maturation. This finding is novel and, in our opinion, very important in the field of the selection of oocytes to be fertilized.

As known, the oocytes obtained under ovarian stimulation present a variable competence and although molecular approaches have been proposed [25,26], the selection is still performed on morphological characteristics such as ploidy and chromosome/chromatin status. Since maturation of oocytes is so important for in vitro fertilization approaches, we suggest sICAM-1 to be a marker for testing different culture mediums under development

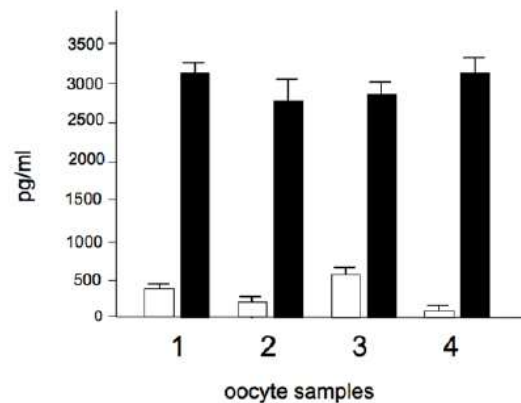

**Figure 6.** Comparison of levels of sICAM-1 (black boxes) and sHLA-G (white boxes) in supernatants of representative oocytes. For sHLA-G detection, covalent coupling of the anti-sHLA-G antibodies to the carboxylated polystyrene microspheres (Bio-Rad, Hercules, CA, USA) was performed using the Bio-Plex amine coupling kit (Bio-Rad, Hercules, CA, USA). Bio-Plex assay was performed as elsewhere reported [2].

doi:10.1371/journal.pone.0003970.g006

by several laboratories to the aim to obtain optimal in vitro oocyte maturation.

In conclusion, our data encourage further studies from different laboratories/networks using ICAM-1 as a marker for a positive oocyte maturation.

## Materials and Methods

### Patients

The oocytes employed in this study were obtained from regularly cycling patients attending the Biogenesi Reproductive Medicine Centre of Monza, Italy, for an Assisted Reproduction Technique with In Vitro Maturation Protocol (IVM). Couples included in the trial had an indication to IVF procedure because of infertility due to male factor, tubal factor, stage I/II endometriosis, polycystic ovarian syndrome (PCO) or unexplained cause. All the women included had regular cycles of 26–35 days. A written informed consensus was obtained from all participating couples. We considered just one cycle per couple, and after maturation process we used from one to three oocytes according to the Italian Law 40 on IVF. Following these criteria, 42 women were recruited for the study. Women characteristics are reported in Table 2.

Oocyte recovery was performed by means of transvaginal ultrasound-guided follicle aspiration, using a single lumen aspiration needle (Gynetics cod. 4551-E2 O17- gauge 35 cm) connected to a vacuum pump (Craft Pump pressure 80–90 mmHg). The retrieved oocytes were surrounded by granulosa cells forming a structure known as the cumulus ophorus complex (COC). The COCs were washed with prewarmed Flushing Medium with heparin (Medi-Cult product n. 10760125, Denmark).

The COCs, that for easiness we will define oocytes, were detected under a stereomicroscope, examined and classified on the basis of their morphology. Oocytes with signs of mechanical damage or atresia were discarded.

Immature oocytes were individually cultured in a 4-well culture dish with 0,5 ml of IVM Medium (vial 2 of IVM system medium; Medicult no. 82214010, Denmark) supplemented with rec-FSH 0,075 IU/ml (Serono, Italy), hCG 0,1 IU/ml (Serono, Italy) and 10% Serum Protein Substitute (SPS no. 3010– Sage Media- USA) for other 30 hrs.

**Table 2.** Details of the in vitro maturation procedure.

	Women (n = 42)
Age (years) (mean±SD)	35±3
Number of recovered oocytes per woman (mean±SD)	7±1
Mature oocytes per woman (%)	20–50

doi:10.1371/journal.pone.0003970.t002

Following the maturation period, 250  $\mu$ l of supernatants were collected from each culture system containing a single oocyte and stored at  $-20^{\circ}\text{C}$  until being tested for the presence released proteins.

The oocytes were then classified, one by one, evaluating the presence of the first polar body to confirm Metaphase II stage and their morphological characteristics.

Immature oocytes were classified as Metaphase I (MI), germinal vesicle (GV) and degenerated (DEG) whereas mature oocytes were classified on the first polar body and cytoplasm characteristics in Grade 1: homogenous cytoplasm and round polar body; Grade 2: oocyte with variations in color or cytoplasm granularity and/or presence of inclusions, vacuoles or retractable bodies, but a round polar body; Grade 3: oocyte with variation in color or cytoplasm granularity and/or presence of inclusions, vacuoles or retractable bodies with a fragmented polar body.

Embryos were graded accordingly to cleavage (cell number) and cytoplasmic fragmentation. Embryos were graded as follows on Day 3: Grade 1, blastomeres have equal size and no cytoplasmic fragmentation; Grade 2, blastomeres have equal size and minor cytoplasmic fragmentation involving  $<10\%$  of the embryo; Grade 3, blastomeres have unequal size and fragmentation involving 10–20% of the embryo; Grade 4, blastomeres have equal or unequal size, and moderate to significant cytoplasmic fragmentation covering 20–50% of the embryo; and Grade 5, few blastomeres and severe fragmentation covering  $\geq 50\%$  of the embryo [17].

#### Measurement of sICAM-1 levels by enzyme-immunosorbent assay (ELISA)

sICAM-1 concentrations were analyzed in triplicate on 1:2 diluted oocyte culture supernatants by the commercially available sICAM-1 kit (Diacione, Besancon, FR) with a detection limit of 0.25 ng/ml.

#### Western blotting

The presence of sICAM-1 molecules in oocyte culture supernatants was analyzed by Western Blot. Briefly, concentrated and albumin depleted (Enchant Life Science kit, Pall Corporation, MI, US) oocyte culture supernatants were loaded on 8% SDS-polyacrylamide gel, electrophoresed at 80 V for 2 hours and blotted onto PVDF membrane (Immobilon-P Millipore, Billerica, MA, US) by electrotransfer at 100 V for 45 minutes in 25 mM Tris Buffer, 190 mM Glycine, 2% SDS and 20% (V/V) Methanol. Blocking was carried out with 5% nonfat dry milk, Tris 100 mM pH 7.5, NaCl 150 mM over night at  $4^{\circ}\text{C}$ . After two washes, the membrane was incubated with monoclonal mouse-anti-human ICAM-1 (10  $\mu\text{g}/\text{ml}$ ) (Genzyme, MA, USA) for 3 hours at room temperature with gentle shaking. The sICAM-1 molecules were detected using Protein-G HRP (BioRad, Hercules, CA, US) at dilution of 1:5000 in 10 mM Tris pH 8.0, 150 mM NaCl, 0.1% Tween 20. Reactions were developed by chemiluminescence with SuperSignal enhanced chemiluminescence kit (Super Signal West

Pico system, Pierce, Rockford, IL, US) and captured by Chemiluminescence Imaging Geliance 600 (PerkinElmer, CT, USA). The ELISA standard (sICAM-1 kit (Diacione, Besancon, FR)) and a plasma sample were used as positive control, the culture medium alone as negative control. The molecular weights were determined with the BenchMark (Invitrogen, CA, US) pre-stained protein ladder (range 10–200 kD). Densitometric analysis was performed with the Gene Tools software (PerkinElmer, CT, USA).

#### Cyto/chemokines and ICAM-1 profiles

Cytokines and chemokines presence were measured in embryo culture supernatants by Bio-Plex cytokine assay (Bio-Rad Laboratories, Hercules, CA) [15,16] described by the manufacturer. The Bio-Plex cytokine assay is designed for the multiplexed quantitative measurement of multiple cytokines in a single well using as little as 50  $\mu$ l of sample. In our experiments, we used the premixed multiplex beads of the and Bio-Plex Human Cytokine singleplex Assay ICAM-1 (Bio-Rad, Cat. no. XF0-000003N) and Bio-Plex human cytokine Human 27-Plex Panel (Bio-Rad, Cat. no. 171-A11127) which included twenty-seven cytokines [IL-1 $\beta$ , IL-1 $\alpha$ , IL-2, IL-4, IL-5, IL-6, IL-7, IL-8, IL-9, IL-10, IL-12 (P70), IL-13, IL-15, IL-17, Basic FGF, Eotaxin, G-CSF, GM-CSF, IFN- $\gamma$ , IP-10, MCP-1 (MCAF), MIP-1 $\alpha$ , MIP-1 $\beta$ , PDGF-BB, RANTES, TNF- $\alpha$ , VEGF]. Briefly, 50  $\mu$ l of cytokine/chemokine and ICAM-1 standards or samples (supernatants from IVF human embryos) were incubated with 50  $\mu$ l of anti-cytokine/chemokine/ICAM-1 conjugated beads in 96-well filter plates for 30 min at room temperature with shaking. Plates were then washed by vacuum filtration three times with 100  $\mu$ l of Bio-Plex wash buffer, 25  $\mu$ l of diluted detection antibody were added, and plates were incubated for 30 min at room temperature with shaking. After three filter washes, 50  $\mu$ l of streptavidin-phycoerythrin was added, and the plates were incubated for 10 min at room temperature with shaking. Finally, plates were washed by vacuum filtration three times, beads were suspended in Bio-Plex assay buffer, and samples were analyzed on a Bio-Rad 96-well plate reader using the Bio-Plex Suspension Array System and Bio-Plex Manager software (Bio-Rad Laboratories, Hercules, CA).

#### Statistical analysis

Statistical analysis was conducted using the Stat View software package (SAS Institute Inc, Cary, NC, US). The data were analyzed by the Student t test for unpaired samples. Statistical significance was assumed for  $p < 0.05$  (two tailed).

#### Author Contributions

Conceived and designed the experiments: RR OB RG. Performed the experiments: MB MS. Analyzed the data: MB RR MMR MS OB RG. Contributed reagents/materials/analysis tools: MBDC DF MMR RF. Wrote the paper: RF OB RG.

#### References

- Deonandan R, Campbell MK, Ostbye T, Tummon I (2000) Toward a more meaningful *in vitro* fertilization success rate. *J Assist Reprod Genet* 17: 498–503.
- Rebmann V, Switala M, Euc I, Schwahn E, Merzenich M, Grosse-Wilde H (2007) Rapid evaluation of soluble HLA-G levels in supernatants of *in vitro* fertilized embryos. *Human Immunol* 68: 251–258.
- Fuzzi B, Rizzo R, Criscuolo L, Noci I, Melchiorri L, et al. (2002) HLA-G expression in early embryos is a fundamental prerequisite for the attainment of pregnancy. *European J Immunol* 32: 311–315.
- Noci I, Fuzzi B, Rizzo R, Melchiorri L, Criscuolo L, et al. (2005) Embryonic soluble HLA-G as a marker of developmental potential in embryos. *Human Reprod* 20: 138–146.
- Sher G, Keskinete L, Batzofin J, Fisch J, Acacio B, et al. (2005) Influence of early ICSI-derived embryo sHLA-G expression on pregnancy and implantation rates: a prospective study. *Human Reprod* 20: 1359–1363.
- Desai N, Filipovits J, Goldfarb J (2006) Secretion of soluble HLA-G by day 3 human embryos associated with higher pregnancy and implantation rates: assay of culture media using a new ELISA kit. *Reprod Biomed Online* 13: 272–277.
- Ye SM, Balakier H, Motamedi G, Lührach CL (2005) Secretion of human leukocyte antigen-G by human embryos is associated with a higher *in vitro* fertilization pregnancy rate. *Fertil Steril* 83: 30–36.
- Ebner T, Yaman C, Moser M, Sommergruber M, Feichtinger O, Tews G (2000) Prognostic value of first polar body morphology on fertilization rate and embryo quality in intracytoplasmic sperm injection. *Human Reproduction* 15: 427–430.



9. Ebner T, Moser G, Tews G (2006) Is oocyte morphology prognostic of embryo developmental potential after ICSI? *Reproductive BioMedicine Online* 12: 507–512.
10. Shen Y, Staff T, Mehnert C, Eichenlaub-Ritter U, Tinneberg HR (2005) High magnitude of light retardation by the zona pellucida is associated with conception cycles. *Human Reproduction* 20: 1596–1606.
11. Montag M, Schimming T, Köster M, Zhou C, Dorn C, et al. (2008) Oocyte zona birefringence intensity is associated with embryonic implantation potential in ICSI cycles. *Reproductive BioMedicine Online* 16: 239–244.
12. Pascale M-P, Chretien M-F, Makhry Y, Reynier P (2007) Mitochondrial DNA in the oocyte and the developing embryo. *Current Topics in Developmental Biology* 77: 51–83.
13. Madaschi C, de Souza Bonetti TC, de Almeida Ferreira Braga DP, Pasqualoto FF, Iaconelli A Jr, Borges E Jr (2008) Spindle imaging: a marker for embryo development and implantation. *Fertil Steril* 90: 194–198.
14. Dumollard R, Duchon M, Carroll J (2007) The role of mitochondrial function in the oocyte and embryo. *Curr Top Dev Biol* 77: 21–49.
15. de Jager W, te Velthuis H, Prakken BJ, Kuis W, Rijkers GT (2003) Simultaneous detection of 15 human cytokines in a single sample of stimulated peripheral blood mononuclear cells. *Clin Diagn Lab Immunol* 10: 133–139.
16. Kerr JR, Cunniffe VS, Kelleher P, Smith J, Vallely PJ, Will AM, et al. (2004) Circulating cytokines and chemokines in acute symptomatic parvovirus B19 infection: negative association between levels of pro-inflammatory cytokines and development of B19-associated arthritis. *J Med Virol* 74: 147–155.
17. Vecek L (1999) *An Atlas of Human Gametes and Conceptuses*. New York: Parthenon Publishing, pp 47–50.
18. Rizzo R, Fuzzi B, Stignani M, Criscuoli L, Melchiorri L, et al. (2007) Soluble HLA-G molecules in follicular fluid: a tool for oocyte selection in IVF? *J Reprod Immunol* 74: 133–142.
19. Fineschi V, Neri M, Turillazzi E (2005) The new Italian law on assisted reproduction technology. *J Med Ethics* 31: 536–539.
20. Hallahan DE, Virudachalam S (1997) Intercellular adhesion molecule 1 knockout abrogates radiation induced pulmonary inflammation. *Proc Natl Acad Sci USA* 94: 6432–6437.
21. Wang HW, Babic AM, Mitchell HA, Liu K, Wagner DD (2005) Elevated soluble ICAM-1 levels induce immune deficiency and increase adiposity in mice. *FASEB J* 19: 1018–1020.
22. Arkan C, Berdeli A, Kılıc M, Tunçgor G, Yagci RV, Aydogdu S (2008) Polymorphisms of the ICAM-1 gene are associated with biliary atresia. *Dig Dis Sci* 53: 2000–2004.
23. van den Borne SW, Narula J, Voncken JW, Lijnen PM, Vervoort-Peters HT, et al. (2008) Defective intercellular adhesion complex in myocardium predisposes to infarct rupture in humans. *J Am Coll Cardiol* 51: 2184–2192.
24. Mousavi SA, Nikseresh AR, Arandi N, Borhani Haghighi A, Ghaderi A (2007) Intercellular adhesion molecule-1 gene polymorphism in Iranian patients with multiple sclerosis. *Eur J Neurol* 14: 1397–1399.
25. Coticchio G, Sereni E, Serrao L, Mazzone S, Iadarola I, Borini A (2004) What criteria for the definition of oocyte quality? *Annals New York Academy of Science* 1034: 132–144.
26. Patrizio P, Fragouli E, Bianchi V, Borini A, Wells D (2007) Molecular methods for selection of the ideal oocyte. *Reproductive BioMedicine Online* 15: 346–353.

## **Allergic women have reduced sHLA-G plasma levels at delivery**

Roberta Rizzo, PhD, Marina Stignani, PhD, Petra Amoudruz<sup>2</sup>, PhD, Caroline Nilsson<sup>3</sup>, MD, PhD Loredana Melchiorri, PhD, Olavio Baricordi, PhD, Eva Sverreremark-Ekström<sup>2</sup>, PhD.

<sup>1</sup>Department of Experimental and Diagnostic Medicine, Laboratory of Immunogenetics, University of Ferrara, Via Luigi Borsari, 46 – 44100 Ferrara, Italy.

<sup>2</sup> Department of Immunology, Wenner-Gren Institute, Stockholm University, Stockholm, Sweden.

<sup>3</sup> Department of Clinical Science and Education, Sodersjukhuset, Karolinska Institutet and Sachs' Children's Hospital, Stockholm, Sweden

Running head: Plasma soluble HLA-G during and after pregnancy

Corresponding author:

Roberta Rizzo, PhD, Department of Experimental and Diagnostic Medicine - Laboratory of Immunogenetics - University of Ferrara - Via Luigi Borsari , 46 – 44100 Italy

E- mail: rbr@unife.it

Tel: ++39 0532 455383

Fax: ++39 0532 455380

## **ABSTRACT**

### **Problem**

HLA-G antigen maintains a tolerogenic condition at the feto-maternal interface, counteracts inflammation in autoimmune diseases and soluble HLA-G (sHLA-G) levels decrease in allergic-asthmatics. Taking into consideration these findings we analyzed if sHLA-G and IL-10 could be influenced by pregnancy and labour in allergic and non-allergic women.

### **Method of Study**

sHLA-G isoforms and interleukin 10 (IL-10) levels were determined in the plasma samples of 43 women (15 non-allergic, 28 allergic) during third trimester, at delivery and 2 years after pregnancy by immunoenzymatic assays.

### **Results**

A significant increase in sHLA-G and IL-10 levels was documented at delivery in both allergic and non-allergic women. Allergic women showed lower sHLA-G concentrations. sHLA-G1 was evidenced as the predominant plasma isoform.

### **Conclusions**

The data propose an impressive boost in sHLA-G and IL-10 concentrations at delivery, regardless of the allergic status. The sHLA-G1 isoform is the main responsible for the increased sHLA-G levels at delivery.

**Key words:** delivery, HLA-G5, plasma, sHLA-G1

## **INTRODUCTION**

In the last years it has been demonstrated that HLA-G antigens are likely to play a pivotal role during pregnancy<sup>1, 2</sup>. The HLA-G antigens are currently defined as non-classical MHC Ib antigens characterized by low allelic polymorphism and restricted tissue distribution. Furthermore, the presence of alternative mRNA splicing can generate different membrane-bound (HLA-G1, -G2, -G3, -G4) and soluble isoforms (HLA-G5, -G6, -G7)<sup>3</sup>. The expression of HLA-G molecules was first described in

extravillous cytotrophoblast cells, and it was further associated with the development and maintenance of a tolerogenic condition against the semiallogenic fetus<sup>4</sup>. Later, HLA-G expression has also been identified in adult thymic medulla, cornea, nail matrix, immature erythroid cells and pancreas<sup>5</sup>. Several reports have confirmed the possibility of membrane and soluble HLA-G molecules (sHLA-G) in the protection of the fetus from the deleterious effects of maternal immune cells. HLA-G molecules are able to induce apoptosis in CD8<sup>+</sup> T cells via a Fas-FasL-dependent mechanism<sup>6,7</sup>, to inhibit natural killer cell activity<sup>8</sup> and allo-specific CD4<sup>+</sup> T cell proliferation<sup>9</sup>, to enhance regulatory CD4<sup>+</sup> T cells<sup>10</sup> and to inhibit the differentiation of dendritic cells<sup>11</sup>. Overall, these effects propose HLA-G molecules as efficient mediators of immunosuppressive functions against innate and adaptive immune responses.

HLA-G expression itself is also regulated by the immune system. For example, interleukin 10 (IL-10) up-regulates HLA-G surface expression on decidual stromal cells, while it is down-regulated by IL-2<sup>12</sup>.

sHLA-G concentrations in serum/plasma of pregnant women have been associated to clinical outcome<sup>1</sup>. sHLA-G levels in plasma from women who subsequently develop preeclampsia are lower than control patients, as early as in the first trimester<sup>13</sup>. In comparison to non-pregnant women, sHLA-G levels strongly increase during the first trimester. Interestingly, women with significantly decreased sHLA-G levels in the second trimester have an increased risk of developing preeclampsia and/or intrauterine growth retardation (IUGR)<sup>13</sup>.

Pregnancy is further associated with alterations in cytokine levels. We have previously demonstrated an increase of spontaneous IL-10 production during pregnancy compared to two years after pregnancy<sup>14</sup>. IL-10 is one of the main enhancers of HLA-G production, with a clear feed-back loop interaction between these two molecules<sup>15</sup>.

We have further demonstrated the relationship between sHLA-G and IL-10 in a study where we described a clear decrease of sHLA-G and IL-10 levels in asthmatic patients<sup>16</sup>. This indicates that sHLA-G levels could be affected in conditions where there is an altered cytokine balance.

The aim of this study was to analyze possible differences in sHLA-G production in allergic and non-allergic pregnant women. We analyzed the levels of soluble HLA-G, the two isoforms sHLA-G1 and sHLA-G5, as well as IL-10 in plasma from 43 women (28 allergic and 15 non-allergic) at two time-points during pregnancy (third trimester, delivery) as well as 2 years after pregnancy.

## **MATERIALS AND METHODS**

### **Study subjects and diagnosis of allergy**

Plasma samples were randomly selected from women participating in a larger prospective study on allergic heredity including 281 infants and their parents, described in detail elsewhere<sup>15</sup>. The women were classified as allergic ( $n = 28$ ) or non-allergic ( $n = 15$ ) (Table I) based on their clinical history (allergic bronchial asthma and/or allergic rhinoconjunctivitis to animal dander and/or to pollen) together with skin prick test (SPT) results. The same nurse performed SPT according to the manufacturer's recommendation (ALK, Copenhagen, Denmark) against the following inhalant allergens: birch, timothy, mugwort, horse, rabbit cat, dog, and *Dermatophagoides farinae* (Soluprick 10 Histamine Equivalent Prick). Histamine chloride (10mg/mL) served as the positive control and the allergen diluent as the negative control. The SPT has been considered positive if the weal diameter after 15min was  $\geq 3$ mm.

Demographic data are shown in Table I. All pregnancies were term pregnancies ( $> 37$  weeks) and all infants had birth weights within the normal range. There were no statistically significant differences regarding maternal age, mode of delivery, sex of child, or the number of children between the two groups. The clinician (CN) who met all families both before and after the delivery recorded that the women unwillingly used inhalation steroids, antihistamines or other drugs. None of the women used systemic steroids. Approval from the Human Ethics Committee at Huddinge University Hospital, Stockholm, Sweden has been granted. All families have given their informed consent to the study.

## **Samples**

Plasma samples were obtained from peripheral blood samples collected from the same women at 3 time points; during the 3<sup>rd</sup> trimester of pregnancy, at delivery and at a non-pregnant state 2 years post-partum. All of the samples were stored at -20°C until analysis. The samples were thawed prior to the ELISA assay and freezing and thawing of the samples was avoided.

## **Cytometric Bead Array**

Levels of IL-10 in plasma were measured using the Cytometric Bead Array (CBA, BD Biosciences Pharmingen, San Diego, CA, USA) technique according to the recommendations from the manufacturer. Briefly, the standards and samples were diluted in assay diluent mixed with the PE-labeled beads and incubated for 3 h. After incubation the samples and standards were washed to remove unbound material and analyzed using the BD CBA software (BD Biosciences Pharmingen, San Diego, CA, USA). Calibration of the flow cytometer was been performed by using BD FACSComp™ (BD Biosciences Pharmingen, San Diego, CA, USA) and BD CaliBRITE™ Beads (BD Biosciences Pharmingen, San Diego, CA, USA). The assay sensitivity was 3.3 pg/ml.

## **Measurement of total sHLA-G levels by enzyme-immunosorbent assay (ELISA)**

Total sHLA-G (sHLA-G1 and HLA-G5) antigen concentrations were investigated by enzyme immunosorbent assay, as reported in the Essen Workshop on sHLA-G quantification<sup>18</sup>. Briefly, 20 µg/ml MEM-G9 MoAb (Exbio, Praha, Czech Republic) were used as capture antibody and anti-beta 2 microglobulin – HRP conjugated MoAb, (Dako, DK) as detection antibody. The concentration of sHLA-G was estimated as a mean of triplicate plasma samples by absorbance at 450 nm on a microplate reader (Wallac Victor 3, PerkinElmer, Waltham, Massachusetts, USA). HeLa cell wild type culture supernatants were used as negative controls and transfected HeLa-G5 cells (kindly provided by Prof. E.Weiss, Institut für Anthropologie und Genetik, LMU, Munchen, Germany) as positive controls. Culture

supernatants were collected at 90% cell confluence and concentrated by the lyophilization procedure. Following depletion of albumin by the Albumin depletion kit (Enchant Life Science kit, Pall Corporation, MI, US), purification of the sHLA-G proteins was carried out as previously reported<sup>19</sup>. The sHLA-G molecules obtained were used as standards at different dilutions (30, 25, 20, 15, 6, 3, 1.5, 1 ng/ml). The standard curve is shown in Figure 1A. The intra-assay coefficient of variation (CV) is 1.4%, the inter-assay CV was 4.0%. The limit of sensitivity was 1.0 ng/ml.

### **Measurement of HLA-G5 levels by enzyme-immunosorbent assay (ELISA)**

Plasma sample concentrations of HLA-G5 were quantified following the protocol proposed by Rebmann et al.<sup>18</sup>. Briefly, 20 µg/ml 5A6G7 MoAb (Exbio, Praha, Czech Republic) were used as capture antibody and biotinylated anti-HLA class I W6/32 MoAb, (Dako, DK) and extravidin-peroxidase (Sigma-Aldrich, Italy) was used for detection. The concentration of sHLA-G was estimated as a mean of triplicate plasma samples by absorbance at 450 nm on a microplate reader (Wallac Victor 3, PerkinElmer, Waltham, Massachusetts, USA). We used the same standards as the total sHLA-G ELISA. The standard curve is shown in Figure 1B. The intra-assay coefficient of variation (CV) was 2.0%, the inter-assay CV was 3.5%. The limit of sensitivity was 1.0 ng/ml.

### **Determination for non classical sHLA-G1**

After ELISA measurements of plasma levels of total sHLA-G and HLA-G5, the amount of sHLA-G1 was expressed as the difference between total sHLA-G (sHLA-G1 and HLA-G5) and HLA-G5 concentrations.

### **Statistical analysis**

Statistical analyses were performed with STATISTICA 7.1 software (Statsoft Inc., Tulsa, OK, USA), by the Division of Mathematics at Stockholm University (Dr. Jan-Olov Persson). To analyse HLA-G variation over time, Friedman's test was used

and the influence of background variables was measured by logistic regression. Fishers's exact test was used to test for differences in the proportion of HLA-G positive individuals between the two groups. For all results the Mann-Whitney U test was used to test for differences of median values between groups. Correlations between HLA-G levels and IL-6 and IL-10 respectively, was analysed with Spearman rank test. A difference was considered significant if  $p < 0.05$ .

## **RESULTS**

### **Labour influences sHLA-G and IL-10 plasma levels**

To evaluate the effect of pregnancy and labour on the plasma sHLA-G levels, we measured sHLA-G in a total of 43 women (15 non-allergic and 28 allergic) at three occasions, during the 3<sup>rd</sup> trimester, at labour and at 2 years post partum. Soluble HLA-G plasma levels were significantly increased during labour in comparison to the third trimester and two years after delivery (Fig 2A). The IL-10 plasma levels followed the same pattern (Fig 2B).

The Spearman correlation coefficient between sHLA-G and IL-10 plasma levels was calculated for all the individuals at the different time points, but no significant correlations between these factors were observed.

### **Allergy is associated with reduced sHLA-G plasma levels during pregnancy and at delivery**

When subdividing the women according to allergic status, plasma levels of both sHLA-G (Fig 3A) and IL-10 (Fig 3B) presented the same behaviour towards labour. In both groups of women, sHLA-G (non allergic,  $p < 0.001$ ; allergic:  $p < 0.001$ , Friedman test) and IL-10 (non-allergic,  $p < 0.05$ ; allergic,  $p < 0.01$ , Friedman test) levels were elevated at delivery in comparison to the third trimester and two years after delivery. Comparing non-allergic and allergic women at each time point, showed that there was a significant difference in the proportion of sHLA-G positive samples between allergic (11/28) and non-allergic women (14/15) during the 3<sup>rd</sup>



trimester ( $p=0.0009$ , Fisher exact test) with lower HLA-G levels in allergic women ( $p<0.01$ ; Mann Whitney U test). Also, allergic women had lower sHLA-G levels (38.0 ng/ml) than non-allergic women (62.0 ng/ml) at delivery (Fig 3A) ( $p<0.05$ , Mann Whitney U test). Interestingly, no significant differences were evidenced 2 years after pregnancy ( $p=NS$ ; Mann Whitney U test). These differences between sHLA-G levels in allergic and non-allergic women remained after control for background variables in both third trimester ( $p=0.006$ , Logistic regression) and delivery ( $p=0.007$ , Logistic regression).

IL-10 levels increased at delivery in both allergic and non-allergic women, but no significant differences were found between the two groups (Fig 3B).

### **sHLA-G isoform analysis**

The analysis of sHLA-G isoforms (sHLA-G1, HLA-G5) demonstrated that sHLA-G1 was the predominant isoform responsible for the increase of sHLA-G levels in plasma during delivery (Fig 4A, B).

Subdividing the women accordingly to the allergic status revealed that sHLA-G1 increased at delivery both in allergic (from 0 ng/ml in the 3<sup>rd</sup> trimester to 36.0 ng/ml at delivery) and non-allergic (from 22.0 ng/ml in the 3<sup>rd</sup> trimester to 42.2 ng/ml at delivery) women (Fig 4A), with a clear increase during labour in comparison to the third trimester and two years after delivery (non-allergic,  $p<0.0001$ ; allergic,  $p<0.0001$ , Friedman test) and higher levels in non-allergic women both in the third trimester ( $p=0.001$ ; Mann Whitney U test) and at the delivery ( $p<0.05$ ; Mann Whitney U test). Moreover there was a significant difference in the proportion of sHLA-G1 positive samples between allergic (10/28) and non-allergic (14/15) women during the third trimester ( $p=0.0003$ , Fisher exact test).

HLA-G5 levels presented the same concentrations in atopic and non-atopic women at all the three time-points (Fig 4B), with no differences between time points (non-allergic,  $p=NS$ ; allergic,  $p=NS$ , Friedman test).

## DISCUSSION

We focused our study on the comparison of sHLA-G plasma concentrations at third trimester, delivery and two years after pregnancy in allergic and non-allergic women. The results demonstrated an impressive increase of sHLA-G molecules at delivery in both allergic and non-allergic women. Furthermore, our data revealed significantly reduced levels of sHLA-G molecules at delivery in allergic women in comparison to non-allergic women. A similar pattern was observed for plasma IL-10, with increased levels at delivery, but without any difference between allergic and non-allergic women. Plasma levels of IL-6 also increased at delivery, indicating a process of labour at the delivery time point. Our results demonstrate that the delivery process is able to affect both sHLA-G in plasma and systemic cytokine levels in both allergic and non-allergic women,

Interestingly, sHLA-G levels were lower in allergic women than in non-allergic women at delivery. The reduced sHLA-G levels were not caused by deficient IL-10 production, as allergic and non-allergic women presented equal amounts at all three time points investigated. This indicates that other factors involved in sHLA-G production and/or regulation differ between these two groups of women. It is possible that the Th2 cytokine microenvironment present in an allergic individual<sup>20</sup> differently influences the sHLA-G secretion. Of course to definitely prove that allergic status affects the sHLA-G production, it would have been necessary to evaluate these women also prior to pregnancy. As the women were enrolled in the study when visiting the maternity ward, this was not feasible.

Reduced sHLA-G levels have been described in pregnancies complicated by preeclampsia and intra-uterine growth retardation<sup>21, 22</sup>. HLA-G molecules have been implicated in the regulation of uterine natural killer (uNK) cells. The uNK cells are supposed to participate in the process of placentation and being particularly important for the process of uterine spiral artery transformation. A dysregulation of uterine NK cells has been suggested in pregnancy-associated pathological conditions like preeclampsia (PE); and modified HLA-G expression on trophoblasts and/or

altered levels of sHLA-G have been implicated as possible mechanisms for this dysregulation. Soluble HLA-G may contribute locally and further away from the invading trophoblast to trigger functional maturation of the uNK cells and thereby contribute to vascular remodelling and decidualization. Soluble HLA-G levels in plasma from women who subsequently developed PE were lower than control patients, as early as the first trimester<sup>23</sup>. The reduced release of sHLA-G into the maternal circulation in preeclampsia may alter the maternal-fetal immune relationship and thus be involved in the cause of this disorder.

However, the absence of any complication in allergic women and their babies suggests a non-significant clinical influence of the observed differences in sHLA-G plasma levels in comparison to non-allergic women. It is interesting in relation to the old Th1/Th2 pregnancy dogma<sup>24</sup>, suggesting that allergic women with their Th2 profile would have higher parity compared to non-allergic women. This is highly questionable, but the supposed Th2 profile of allergic women could perhaps compensate for the lower sHLA-G levels.

Non-allergic women have higher sHLA-G plasma levels at delivery, while two years after pregnancy, the two groups presented equal levels. Allergic women seem to experience a prime during pregnancy that is still evident two years after pregnancy. These data are in agreement with our recent study that demonstrated the presence of immunological changes imposed by pregnancy still evident two years after labour<sup>16</sup>.

The difference in the levels of sHLA-G between allergic and non-allergic women could be also genetically determined. The HLA-G gene is characterized by a polymorphism of deletion/insertion of 14 base pairs at the 3' untranslated region of the exon 8<sup>25</sup>. This polymorphism influences the stability of the HLA-G mRNA and in particular the presence of the 14bp sequence destabilizes the mRNA and consequently reduces the protein production<sup>17, 26</sup>. This insertion/deletion polymorphism is in linkage disequilibrium with particular alleles in the classical HLA loci including HLA-DR3<sup>27</sup>. Some allergic disorders may be associated with polymorphisms in the HLA region that may be in linkage disequilibrium with this

polymorphism predisposing to low sHLA-G levels. Moreover the HLA-G protein production seems to be controlled also by HLA-G gene polymorphisms at the 5' upstream regulatory region<sup>28</sup>, mutations<sup>29</sup> and microRNAs<sup>30</sup>. It would be interesting to evaluate all these mechanisms in the attempt to explain the different HLA-G production by allergic and non-allergic women.

To better investigate the nature of sHLA-G increase we analyzed the sHLA-G1 and HLA-G5 isoforms, which represent the main components of the total sHLA-G plasma amount. Our data demonstrated that sHLA-G1 molecules were the most frequent isoform in plasma (75-80%) in both allergic and non-allergic women during labour. As sHLA-G1 molecules are considered mainly originated by metalloproteinase (MMP)-dependent shedding at post-translational level of the membrane antigens<sup>31</sup>, it could be hypothesized that sHLA-G1 could derive from the placenta disruption during the labour that is characterized by an increase in MMP-9 amounts<sup>32</sup>.

On the opposite, the production of HLA-G5 soluble isoform is mainly ascribed to splicing mechanisms at gene levels that occur in the IL-10 activated CD14+ peripheral blood monocyte population. IL-10 represents the main activator of CD14+ cells, and it is well accepted that HLA-G5 production mediated by IL-10 represents a mechanism to counteract inflammation. In our study we have observed a significant increase of plasma IL-10 levels at delivery, without any significant difference between allergic and non-allergic women. The increased levels of IL-10 at delivery could affect the HLA-G5 production, associated to an anti-inflammatory response that tries to counteract the inflammatory status of delivery<sup>33</sup>.

In summary our results demonstrate an increase of sHLA-G plasma concentrations at delivery compared to the 3<sup>rd</sup> trimester and 2 years after delivery. sHLA-G plasma levels in allergic women followed the same pattern as in non-allergic women with the highest levels at delivery. However, at delivery, sHLA-G levels were lower in allergic women than in non-allergic women. The reduced sHLA-G levels were not caused by deficient IL-10 production, as allergic and non-allergic women produced equal amounts at all three time points investigated. Further

experiments are needed to understand the mechanisms responsible for the reduced production of sHLA-G in allergic women, that in this study however, did not represent a significant hazard for a normal delivery.

#### **ACKNOWLEDGEMENTS:**

This study was supported by the Swedish Asthma and Allergy Association's Research foundation, the Swedish Research Council (Medicine) grants no 74X-15160-03-2, 57X-15160-05-2 the Swedish Medical Society, the Golden Jubilee Memorial Foundation, the HRH Crown-princess Lovisa & Axel Tielman-,Golje-, Hesselman-, Vardal-, and the Åhlén foundations.

#### **REFERENCES**

- 1) Hunt JS: Stranger in a strange land. *Immunol Rev* 2006; 213: 36-47.
- 2) Hviid TVF: HLA-G in human reproduction: a aspects of genetics, function and pregnancy complication. *Human Reprod Update* 2006; 12: 209-232.
- 3) Ishitani A, Geraghty DE: Alternative splicing of HLA-G transcripts yields proteins with primary structures resembling both class I and class II antigens. *Proc Natl Acad Sci U S A* 1992; 89: 3947-3951.
- 4) Rouas-Freiss N, Gonçalves RM, Menier C, Dausset J, Carosella ED: Direct evidence to support the role of HLA-G in protecting the fetus from maternal uterine natural killer cytotoxicity. *Proc Natl Acad Sci U S A*. 1997; 94: 11520-11525.
- 5) Carosella ED, Moreau P, Aractingi S, Rouas-Freiss N: HLA-G: a shield against inflammatory aggression. *Trends Immunol* 2001; 22: 553-555.
- 6) Fournel S, Aguerre-Girr M, Huc X, Lenfant F, Alam A, Toubert A, Bensussan A, Le Bouteiller P: Cutting edge: soluble HLA-G1 triggers

- CD95/CD95 ligand-mediated apoptosis in activated CD8<sup>+</sup> cells by interacting with CD8. *J Immunol* 2000; 164: 6100-6104.
- 7) Contini P, Ghio M, Poggi A, Filaci G, Indiveri F, Ferrone S, Puppo F: Soluble HLA-A,-B,-C and -G molecules induce apoptosis in T and NK CD8<sup>+</sup> cells and inhibit cytotoxic T cell activity through CD8 ligation *Eur J Immunol* 2003; 33: 125-134.
  - 8) Riteau B, Rouass-Freiss N, Menier, C, Paul, P, Dausset, J, Carosella ED: HLA-G2, -G3, and -G4 isoforms expressed as nonmature cell surface glycoproteins inhibit NK and antigen-specific CTL cytotoxicity. *J Immunol* 2001; 166: 5018-5026.
  - 9) Bainbridge DR, Ellis SA, Sargent IL: HLA-G suppresses proliferation of CD4(+) T-lymphocytes. *J Reprod Immunol* 2000; 48: 17-26.
  - 10) LeMaoult J, Krawice-Radanne I, Dausset J, Carosella ED: HLA-G1-expressing antigen-presenting cells induce immunosuppressive CD4<sup>+</sup> T cells. *Proc Natl Acad Sci U S A* 2004; 101: 7064-7069.
  - 11) Gros F, Cabillic F, Toutirais O, Maux AL, Sebti Y, Amiot L: Soluble HLA-G molecules impair natural killer/dendritic cell crosstalk via inhibition of dendritic cells. *Eur J Immunol*. 2008; 38: 742-749.
  - 12) Blanco O, Tirado I, Muñoz-Fernández R, Abadía-Molina AC, García-Pacheco JM, Peña J, Olivares EG: Human decidual stromal cells express HLA-G: Effects of cytokines and decidualization. *Hum Reprod*. 2008; 23: 144-152.
  - 13) Yie SM, Taylor RN, Librach C: Low plasma HLA-G protein concentrations in early gestation indicate the development of preeclampsia later in pregnancy. *Am J Obstet Gynecol*. 2005; 193: 204-208.
  - 14) Amoudruz P, Minang JT, Sundström Y, Nilsson C, Lilja G, Troye-Blomberg M, Sverremark-Ekström E: Pregnancy, but not the allergic status, influences spontaneous and induced interleukin-1beta (IL-1beta), IL-6, IL-10 and IL-12 responses. *Immunology*. 2006; 119: 18-26.

- 15) Rizzo R, Hviid TV, Stignani M, Balboni A, Grappa MT, Melchiorri L, Baricordi OR: The HLA-G genotype is associated with IL-10 levels in activated PBMCs. *Immunogenetics*. 2005; 57: 172-181.
- 16) Rizzo R, Mapp CE, Melchiorri L, Maestrelli P, Visentin A, Ferretti S, Bononi I, Miotto D, Baricordi OR: Defective production of soluble HLA-G molecules by peripheral blood monocytes in patients with asthma. *J Allergy Clin Immunol*. 2005; 115: 508-513.
- 17) Nilsson C, Linde A, Montgomery SM, Gustafsson L, Näsman P, Blomberg MT, Lilja G: Does early EBV infection protect against IgE sensitization? *J Allergy Clin Immunol* 2005; 116: 438-444.
- 18) Rebmann V, LeMaout J, Rouas-Freiss N, Carosella ED, Grosse-Wilde H: Quantification and identification of soluble HLA-G isoforms. *Tissue Antigens*. 2007; 69: 143-149.
- 19) LeFric G, Laupeze B, Fardel O, Sebti Y, Pangault C, Guilloux V, Beauplet A, Fauchet R, Amiot L: Soluble HLA-G inhibits human dendritic cell-triggered allogeneic T-cell proliferation without altering dendritic differentiation and maturation processes. *Hum Immunol* 2003; 64: 752-761.
- 20) Akkoc T, de Koning PJ, Rückert B, Barlan I, Akdis M, Akdis CA: Increased activation-induced cell death of high IFN-gamma-producing T(H)1 cells as a mechanism of T(H)2 predominance in atopic diseases *J Allergy Clin Immunol*. 2008; 121: 652-658.
- 21) Yie SMA, Li LH, Li YM, Librach C: HLA-G protein concentrations in maternal serum and placental tissue are decreased in preeclampsia. *Am J Obstet Gynecol* 2004; 191: 525-529.
- 22) Steinborn A, Varkonyi T, Scharf A, Bahlmann F, Klee A, Sohn C: Early detection of decreased soluble HLA-G levels in the maternal circulation predicts the occurrence of preeclampsia and intrauterine growth retardation during further course of pregnancy. *Am J Reprod Immunol*. 2007; 57: 277-286.

- 23) Yie SM, Taylor RN, Librach C: Low plasma HLA-G protein concentrations in early gestation indicate the development of preeclampsia later in pregnancy. *Am J Obstet Gynecol.* 2005; 193: 204-208.
- 24) Chaouat G: The Th1/Th2 paradigm: still important in pregnancy? *Semin Immunopathol.* 2007; 29: 95-113.
- 25) Hviid TV, Hylenius S, Rørbye C, Nielsen LG: HLA-G allelic variants are associated with differences in the HLA-G mRNA isoform profile and HLA-G mRNA levels *Immunogenetics* 2003; 55: 63-79.
- 26) Chen XY, Yan WH, Lin A, Xu HH, Zhang JG, Wang XX: The 14 bp deletion polymorphisms in HLA-G gene play an important role in the expression of soluble HLA-G in plasma. *Tissue Antigens* 2008; 72: 335-341.
- 27) Hviid TV, Christiansen OB. Linkage disequilibrium between human leukocyte antigen(HLA) class II and HLA-G - possible implications for human reproduction and autoimmune disease. *Hum Immun* 2005; 66: 688-699.
- 28) Hviid TV, Rizzo R, Melchiorri L, Stignani M, Baricordi OR: Polymorphism in the 5' upstream regulatory and 3' untranslated regions of the HLA-G gene in relation to soluble HLA-G and IL-10 expression. *Hum Immunol* 2006: 53-62.
- 29) Yie SM, Li LH, Xiao R, Librach CL: A single base-pair mutation in the 3'-untranslated region of HLA-G mRNA is associated with preeclampsia. *Mol Hum Reprod* 2008 in press.
- 30) Veit TD, Chies JA: Tolerance versus immune response - MicroRNAs as important elements in the regulation of the HLA-G gene expression. *Transpl Immunol* 2008 in press.
- 31) Dong Y, Lieskovska J, Kedrin D, Porcelli S, Mandelboim O, Bushkin Y: Soluble nonclassical HLA generated by the metalloproteinase pathway. *Hum Immunol.* 2003; 64: 802-810.
- 32) Cataldo DD, Bettiol J, Noël A, Bartsch P, Foidart JM, Louis R: Matrix metalloproteinase-9, but not tissue inhibitor of matrix metalloproteinase-1,



increases in the sputum from allergic asthmatic patients after allergen challenge. Chest 2002;122: 1553-1559.

- 33) Romero R, Espinoza J, Goncalves LF, Kusanovic JP, Friel LA, Nien JK: Inflammation in preterm and term labour and delivery. Semin Fetal Neonatal Med 2006; 11: 317-326.

**Table I.**

Demographic data of allergic and non-allergic women

	Allergic women (n=28)	Non-Allergic women (n=15)	p value <sup>°</sup>
Maternal age at delivery (years)	32 24 - 44	32 27 - 40	0.2975
Gestation length (months)	40 37 - 42	40 38 - 43	0.5770
Mode of delivery	*ECS: 4/28 VD: 24/28	ECS: 2/15 VD: 13/15	0.9323
Sex of child	Girl: 14/28 Boy: 14/28	Girl: 10/15 Boy: 5/15	0.2999
Number of children	1 1 - 4	2 1 - 3	0.6427

\*ECS: elective caesarean section; VD: vaginal delivery

<sup>°</sup> Mann Whitney sum of rank test

### **Legends to figure**

Figure 1. Standard curve of the ELISA assays for total sHLA-G (A) and HLA-G5 isoform (B). The standard sHLA-G was used at different dilution (30, 25, 20, 15, 6, 3, 1.5, 1 ng/ml) in triplicate. The enzyme-linked immunosorbent assays were performed as described in the Material and Methods section. The detection limit, 3.29 SD added to the mean optical density of repeated negative control measurements, is reported (Dotted line). The bold line indicates the linear regression and the dashed lines the 95% confidence interval.

Figure 2. Molecule levels in plasma samples from 43 pregnant women (allergic and non-allergic) at the third trimester (3<sup>rd</sup>), delivery (del) and 2 years after delivery (2ys) measured by enzyme-linked immunosorbent assay. (A) sHLA-G; (B) IL-10. \* Difference between time points (Friedman test); ° Mann Whitney U test, was used to test for differences of median values between groups.

Figure 3. Soluble HLA-G (A) and IL-10 (B) levels in plasma samples from 15 non-allergic (grey) and 28 allergic (white) women at the third trimester (3<sup>rd</sup>), delivery (del) and 2 years after delivery (2ys) measured by enzyme-linked immunosorbent assay. \* Difference between time points (Friedman test); ° Mann Whitney U test, was used to test for differences of median values between groups.

Figure 4. Soluble HLA-G1 (A) and HLA-G5 (B) isoform levels in plasma samples from 15 non-allergic (grey) and 28 allergic (white) women at the third trimester (3<sup>rd</sup>), delivery and 2 years after delivery (2ys) measured by enzyme-linked immunosorbent assay. \* Difference between time points (Friedman test); ° Mann Whitney U test, was used to test for differences of median values between groups.

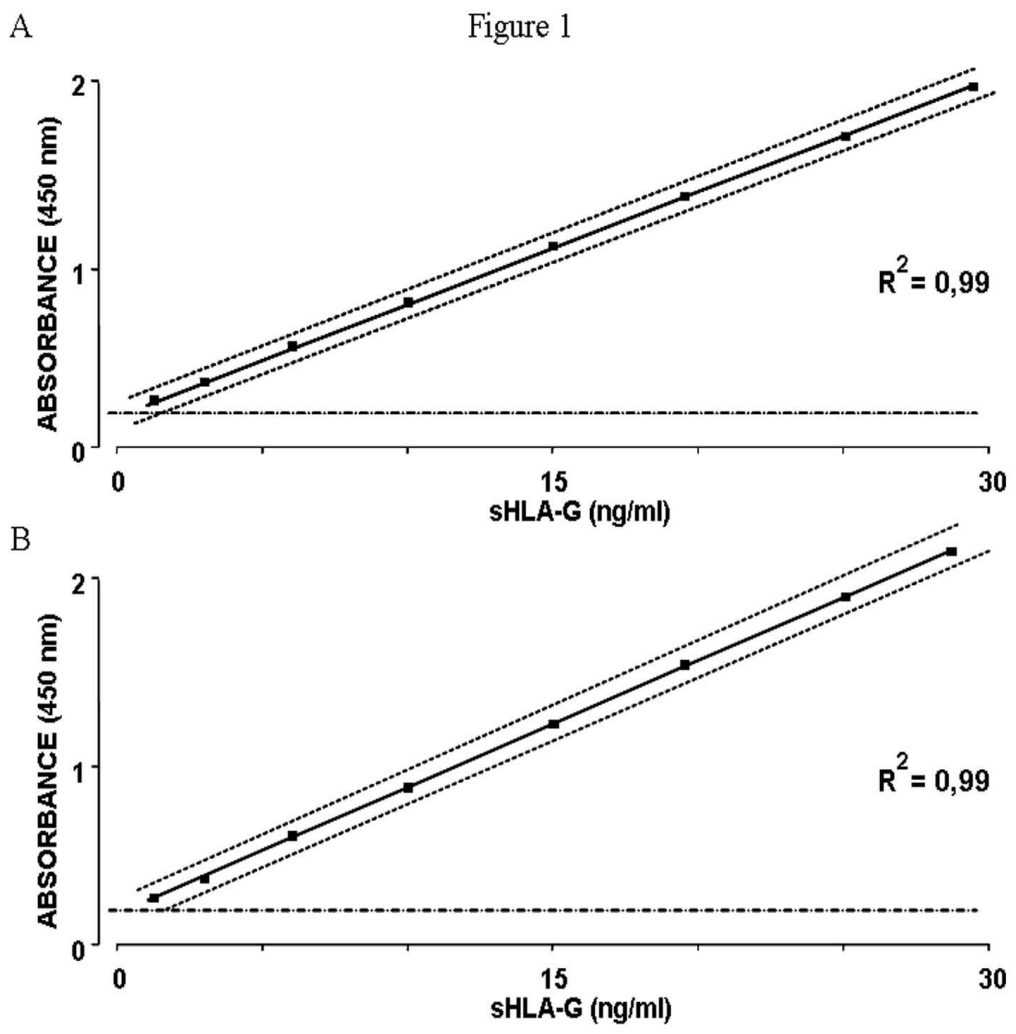

Figure 2

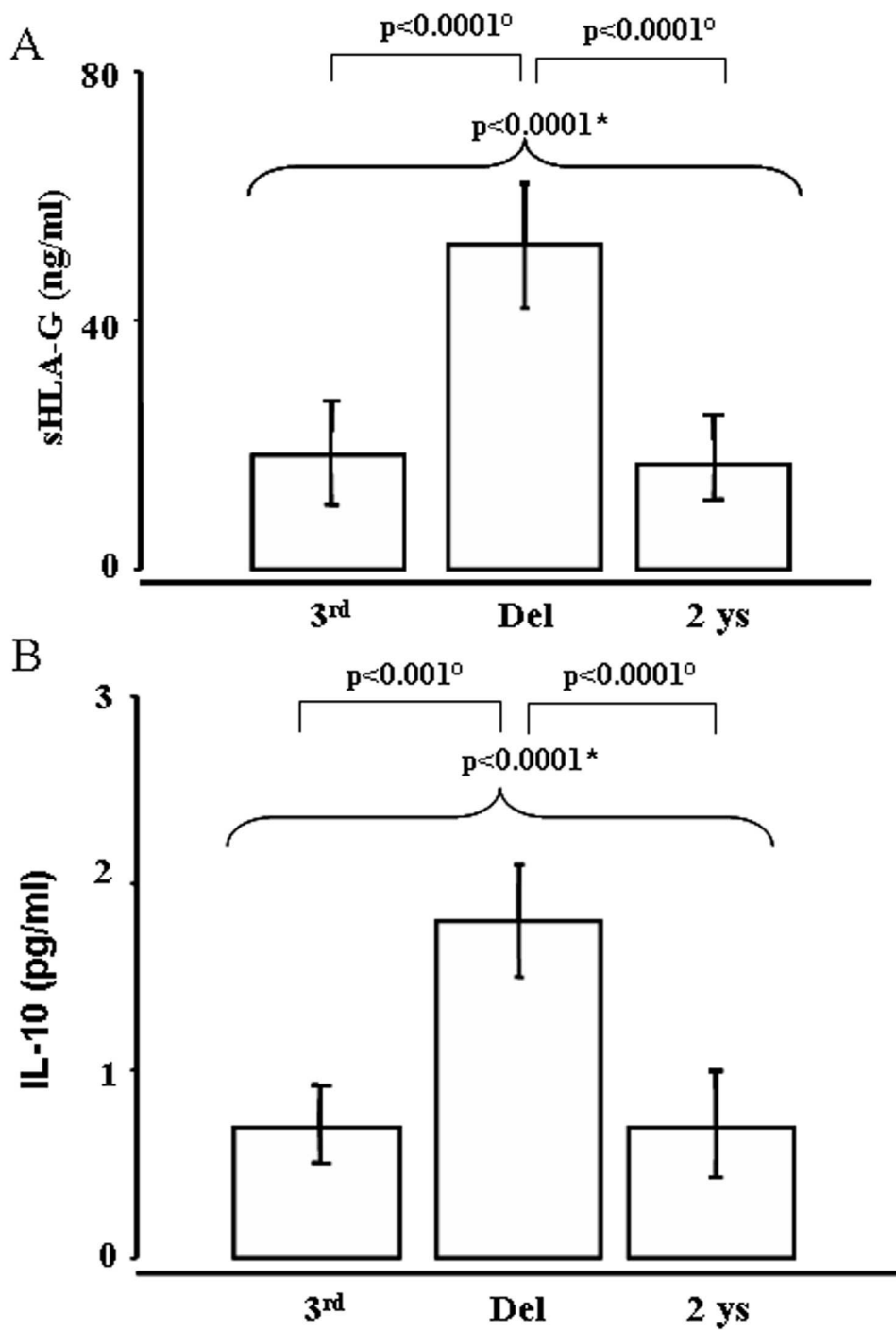

Figure 3

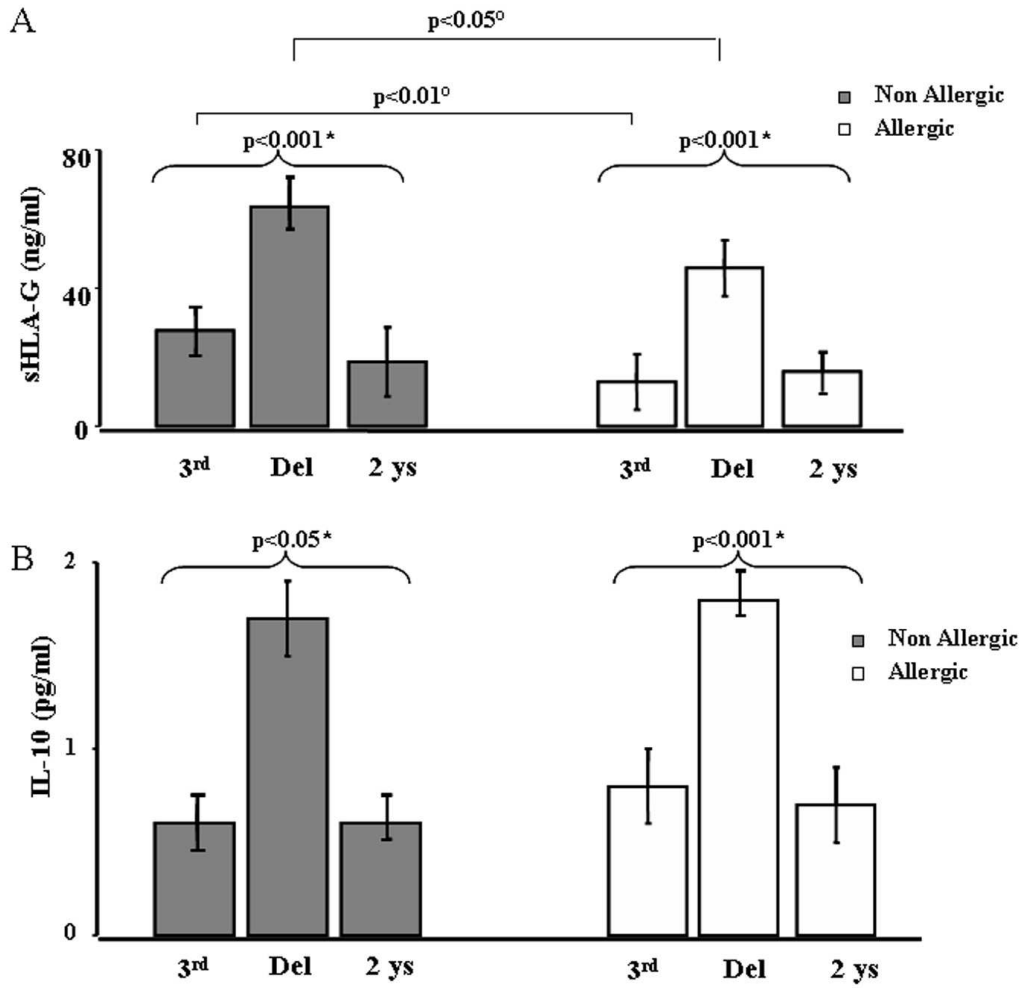
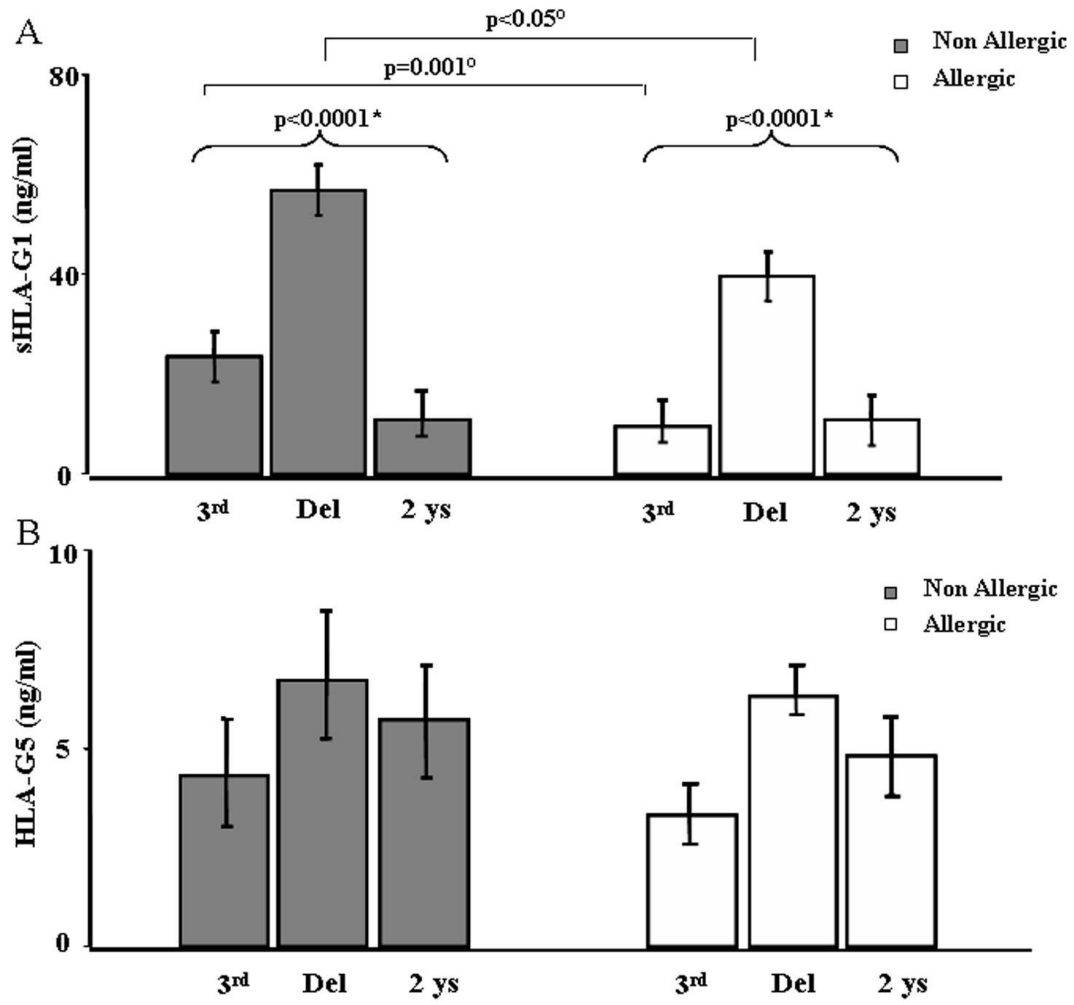

Figure 4



## **Production of sHLA-G molecules by “in vitro” matured cumulus-oocyte complex.**

Roberta Rizzo<sup>1\*</sup>, MariaBeatrice Dal Canto<sup>2\*</sup>, Marina Stignani<sup>1</sup>, Rubens Fadini<sup>2</sup>, Daniela Fumagalli<sup>2</sup>, Mario Mignini Renzini<sup>2</sup>, Monica Borgatti<sup>3</sup>, Roberto Gambari<sup>3</sup>, Olavio Roberto Baricordi<sup>1</sup>.

- 1) Department of Experimental and Diagnostic Medicine, Laboratory of Immunogenetics, University of Ferrara, Via Luigi Borsari, 46 – 44100 Ferrara, Italy.
- 2) BIOGENESI Reproductive Medicine Centre, Istituti Clinici Zucchi, Via Zucchi, 24- 20052 Monza, Italy.
- 3) ER-GenTech, Department of Biochemistry and Molecular Biology, University of Ferrara, Via Fossato di Mortara, 74 - 44100 Ferrara, Italy.

\* Roberta Rizzo and Maria Beatrice Dal Canto contributed equally to this study

Send Correspondences to:

Roberta Rizzo, PhD, Department of Experimental and Diagnostic Medicine - Laboratory of Immunogenetics - University of Ferrara - Via Luigi Borsari , 46 – 44100 Italy

E- mail: rbr@unife.it

Tel: ++39 0532 455383

Fax: ++39 0532 455380

## ***ABSTRACT***

Oocyte selection with the highest competency represent a major goal in IVF. Several studies have demonstrated that non classical HLA class I HLA-G molecule modulation creates a tolerogenic microenvironment at the feto-maternal interface and it seems to be implicated in embryo implantation. This study investigated if soluble HLA-G molecules production by the cumulus-oocyte complex (COC) could be a marker of oocyte maturation. sHLA-G molecule levels were analyzed using Bio-Rad's Bio-Plex assay in 152 COC supernatants obtained from 42 women and matured by an "in vitro maturation procedure". The presence of sHLA-G molecules was confirmed by Western blot technique. The results demonstrate detectable amounts of sHLA-G molecule ranging from 300 to 800 pg/ml in 14/73 (19%) COCs that generated mature oocytes and the complete absence of detectable sHLA-G antigens in the supernatants of COCs that corresponded to immature oocytes.

The detection of sHLA-G molecules in the COC culture supernatants corresponding to matured oocytes is proposed as a possible marker to identify the gametes with a higher functionality. This non-invasive marker could be used in addition to morphological approaches to reduce the number of fertilized oocytes and transferred embryos.

**Key words:** HLA-G; oocyte; in vitro maturation



## 1. INTRODUCTION

Currently, several oocytes are fertilized during IVF procedures and two or more embryos are transferred to the uterus in order to increase the chance of a positive pregnancy. However, this approach results in a high number of multiple pregnancies, perinatal mortality and morbidity. The necessity to overcome these risks together with the presence of ethical problems has increased the interest in selecting the gametes with the highest competency. This point is of extreme interest in Italy, where the law 40/2004 states that no more than three embryos must be created at any one time and all the embryos created must be transferred together even if the couple does not need all the embryos (Fineschi *et al.*, 2005).

In this context the identification of validated markers for oocyte selection represents a fundamental step in IVF.

Several studies have demonstrated that HLA-G antigen modulation creates, by direct and indirect mechanisms, a tolerogenic microenvironment at the feto-maternal interface (Rouas-Freiss *et al.*, 2007). HLA-G molecules inhibit, together with HLA-C and HLA-E, the innate Natural Killer response against cytotrophoblast cells which lack classical HLA class I and II expression (Moffett *et al.*, 2006; Khalil-Daher *et al.*, 1999; Rouas-Freiss *et al.*, 1997;). HLA-G antigens affect the adaptative cellular response inducing the apoptosis of cytotoxic CD8+ T lymphocytes (Le Gal *et al.*, 1999; Fournel *et al.*, 2000), impairing CD4+ T cell functions and preventing dendritic cell maturation (Bainbridge *et al.*, 2000; Lila *et al.*, 2001). HLA-G molecules also induce immunosuppressive regulatory T cell development (Feger *et al.*, 2007; Selmani *et al.*, 2008).

Detectable levels of soluble HLA-G (sHLA-G) molecules in a percentage of follicular fluids (FFs) from patients admitted to IVF procedures have recently been reported (Rizzo *et al.*, 2007) and granulosa cells have been identified as producers of sHLA-G molecules. The granulosa cells which surround the mammalian oocyte are known as the cumulus oophorus. These cells create a structural pathway for cell-to-cell communication (Gilchrist *et al.*, 2004) where cumulus cells provide several trophic or metabolic factors to the preovulatory oocyte (Elvin *et al.*, 1999). Several

results indicate that the measurement of gene transcription levels in cumulus cells would reliably complement the morphological oocyte evaluation providing a useful tool for selecting oocytes with greater chances to be fertilized (Feuerstein *et al.*, 2007; Cillo *et al.*, 2007).

Considering the presence of sHLA-G in FFs during the oocyte maturation this study verified if it is a marker of this process. The culture supernatants of “in vitro matured” oocytes were analyzed for sHLA-G presence. The target of “in vitro maturation” (IVM) technique is to retrieve immature oocytes from the ovary and to induce their maturation in vitro. We have employed *in vitro* co-cultures of oocytes and cumulus cells to restore support from the surrounding cumulus cells to the oocyte (Combelles *et al.*, 2002; Eppig, 1991). This system has allowed us to analyze the sHLA-G production by the cumulus-oocyte complex (COC) without the influence of the *in vivo* maternal microenvironment.

## **2. MATERIALS AND METHODS**

### **2.1 Patients**

The oocyte employed for this study have been obtained from regularly cycling patients attending the Biogenesi Reproductive Medicine Centre of Monza, Italy, for an Assisted Reproduction Technique with In Vitro Maturation Protocol (IVM).

Couples included in the trial had an indication to IVF procedure because of infertility due to male factor, tubal factor, stage I/II endometriosis, polycystic ovarian syndrome (PCO) or unexplained cause. All the women included had regular cycles of 26-35 days. A written informed consensus has been obtained from all participating couples.

We have considered just one cycle per couple. After maturation process we have used from one to three oocytes according to the Italian Law 40 on IVF (Fineschi *et al.*, 2005). Following these criteria, 42 women have been recruited for the study. Women characteristics are reported in Table 1.

Oocyte recovery has been performed by means of transvaginal ultrasonound–guided follicle aspiration, using a single lumen aspiration needle (Gynetics cod. 4551-E2 Ø17- gauge 35 cm) connected to a vacuum pump (Craft Pump pressure 80-90 mmHg). The aspirated follicular fluids, containing COCs, have been washed with prewarmed Flushing Medium with heparin (Medi-Cult product n. 10760125, Denmark). The oocytes have been detected under a stereomicroscope, examined and classified on the basis of their morphology. Oocytes with signs of mechanical damage or atresia have been discarded.

Immature COCs have been individually cultured in a 4-well culture dish with 250µl ml of IVM Medium (vial 2 of IVM system medium; Medicult no. 82214010, Denmark) supplemented with rec–FSH 0,075 IU/ml (Serono, Italy), hCG 0,1 IU/ml (Serono, Italy) and 10% Serum Protein Substitute (SPS no.3010– Sage Media- USA) for 30 hrs.

Following the maturation period, the supernatants have been collected from each culture system containing a single COC and stored at -20°C until being tested for the presence of sHLA-G. The oocytes have been denuded from cumulus and evaluated for the presence of the first polar body to confirm Metaphase II stage. The Metaphase II oocytes have been considered mature, while the Metaphase I, degenerated and germinal vesicle oocytes have been defined immature (Huang et al., 2002). The mature oocytes have been classified accordingly to surrounding cumulus cells as follow: Grade A: expanded cumulus with multilayer and slack cumulus cells with a full adhesion to the oocyte with cumulus; Grade B: full or spare compact cumulus with one to three layers of cumulus cells with a spare adhesion to the oocyte (Table 2a); and graded on the first polar body and cytoplasm characteristics: Grade 1: homogenous cytoplasm and round polar body; Grade 2. oocyte with variations in colour or granularity of the cytoplasm and/or presence of inclusions, vacuoles or retractable bodies , but a round polar body; Grade 3. oocyte with variations in colour or granularity of the cytoplasm and/or presence of inclusions, vacuoles or retractable bodies with a fragmented polar body (Table 2b)). The subdivision of the mature oocytes is reported in Table 3.

## 2.2 sHLA-G ELISA

sHLA-G1, obtained from the proteolytic cleavage of the membrane bound HLA-G1, and HLA-G5, generated by mRNA alternative splicing, have been assayed as reported in Essen Workshop on sHLA-G quantification (Rebmann *et al.*, 2005) using as capture antibody the MoAb MEM-G9 (Exbio, Praha, Czech Republic), which recognizes HLA-G molecule, in beta2-microglobulin-associated form, at the concentration of 20 µg/ml. The anti-beta<sub>2</sub> microglobulin MoAb – HRP conjugated, (Dako, Glostrup, Denmark) has been used as detecting antibody diluted 1:1000 in PBS1x. HeLa cell wild type culture supernatants have been used as negative control, transfected HeLa-G5 cell (kindly provided by Prof. E.Weiss, Institut für Anthropologie und Genetik, LMU, München, Germany) as positive control. Culture supernatants have been collected at cell confluence and concentrated by lyophilization procedure. Following depletion of albumin by Albumin depletion kit (Enchant Life Science kit, Pall Corporation, MI, USA), the purification of the sHLA-G proteins has been carried out as previously reported (Le Friec *et al.*, 2003). The sHLA-G molecules obtained have been used as standard at different dilutions. The COC culture medium has been used for the standard dilution.

The detection limit has been calculated with repeated measurements of a negative control obtained with the culture medium. In this way all the variables of the assay have been considered. We have calculated the mean of the optical density (OD) value obtained in the negative control wells, present in triplicate in each plate, and a standard deviation, with the value of lower limit of detection being 3.29 standard deviations (SD) added to the mean OD value (Anderson DJ, 1989). In this case, there is only a 5% chance of classifying a result in the wrong population and the lower limit of detection sample determinations are above this midway concentration with a probability of the 95%. The limit of sensitivity is 600 pg/ml.

## 2.3 Bio-Plex system

**2.3.1 Covalent coupling of antibodies to microspheres.** Covalent coupling of the anti-sHLAG antibodies to the carboxylated polystyrene microspheres (Bio-Rad, Hercules, CA, USA) has been performed using the Bio-Plex amine coupling kit (Bio-Rad, Hercules, CA, USA). Briefly, the microspheres' stock solution has been dispersed by bath sonication until a homogeneous distribution of the microspheres has been observed. For a 1x scale coupling reaction, 100  $\mu$ l of monodisperse beads ( $1.25 \times 10^6$  microspheres), has been centrifugated at 14,000 x g for 4 min and washed with 100  $\mu$ l of bead wash buffer. This bead pellet has been resuspended in 80  $\mu$ l of bead activation buffer, vortexed for 30 sec, and then sonicated by bath sonication for 30 sec. Solutions of *N*-hydroxysulfosuccinimide (S-NHS) and 1-ethyl-3-(3-dimethylaminopropyl)-carbodiimide hydrochloride (EDC) (Pierce Biotechnology, Rockford, USA), both at 50 mg/ml, have been prepared in bead activation buffer immediately prior to its use, and 10  $\mu$ l of each solution has been sequentially added to stabilize the reaction and activate the microspheres. This suspension has been vortexed for 30 sec and then agitated with a rotator at room temperature for 20 min in the dark. Then activated beads have been washed twice with 150  $\mu$ l of PBS, pH 7.4, incubated with 5  $\mu$ g of MoAb MEM-G9 (Exbio, Praha, Czech Republic) in a final volume of 500  $\mu$ l of PBS, pH 7.4 and agitated with a rotator at 4°C overnight in the dark. After washing with 500  $\mu$ l of PBS, pH 7.4 the beads have been resuspended with 250  $\mu$ l of blocking buffer and agitated at room temperature for 30 min in the dark. The coupled beads have been washed with 500  $\mu$ l of storage buffer, resuspended in 150  $\mu$ l of storage buffer and counted with a hemacytometer.

Coupling efficiency of monoclonal antibodies has been tested by staining 10,000 microspheres with biotinylated antibody directed to the source of the capture antibody (goat anti-mouse immunoglobulin G (e-Bioscience, San Diego, USA) followed by streptavidin-PE for 30 min and 10 min at room temperature in the dark respectively. The microspheres, resuspended in 150  $\mu$ l of storage buffer, have been

measured and analyzed with the Bio-Plex system (Bio-Rad Laboratories, Hercules, CA, USA).

**2.3.2 s-HLAG Bio-plex assay.** COC culture supernatants have been assayed for sHLA-G using a bead array system Bio-Plex (Bio-Rad, Hercules, CA, USA) according to the manufacturer's instructions. Briefly, 50  $\mu$ l of sHLA-G standards (prepared in the same fresh culture medium and assayed in duplicate) or samples (COC culture supernatants in duplicate) have been incubated with 50  $\mu$ l of anti-sHLA-G conjugated beads (5000 beads/well) in 96-well filter plates for 60 min at room temperature with shaking. Plates have been washed by vacuum filtration three times with 100  $\mu$ l of Bio-Plex wash buffer, 25  $\mu$ l of biotinylated antibody W6/32 (10  $\mu$ g/ml) (Dako, Glostrup, Denmark) has been added, and plates were incubated for 30 min at room temperature with shaking. After three filter washes, 50  $\mu$ l of streptavidin-phycoerythrin has been added, and the plates have been incubated for 15 min at room temperature with shaking. Finally, plates have been washed by vacuum filtration three times, beads have been suspended in 125  $\mu$ l of Bio-Plex assay buffer, and samples have been analyzed on the Instrument Bio-Plex system in combination with the Bio-Plex Manager software. The standard curves for sHLA-G have been used from 24000 to 93,75 pg/ml and the minimum detectable dose was 300 pg/ml.

The detection limit has been calculated with repeated measurements of a negative control obtained with the culture medium. In this way we have considered all the variables of the assay. We have calculated the mean of the fluorescence value obtained in the negative control wells, present in triplicate in each plate, and a standard deviation, with the value of lower limit of detection being 3.29 standard deviations (SD) added to the mean fluorescence (FI) value (Anderson DJ, 1989). In this case, there is only a 5% chance of classifying a result in the wrong population and the lower limit of detection sample determinations are above this midway concentration with a probability of the 95%. The specificity of this assay has been validated with an isotype control (Mouse IgG1 Isotype control, code 1B-457-C100 biotin; Exbio, Praha, Czech Republic) used in the place of W6.32 biotin moAb. The

background observed was lower than the selected detection limit (data non shown). We have obtained the limit of sensitivity at 300 pg/ml.

## **2.4 Western blotting**

The presence of HLA-G molecules in COC supernatants have been analysed by denaturing SDS-PAGE in a group of ELISA sHLA-G positive samples (Rizzo *et al.*, 2007). Briefly, 100x concentrated and albumin depleted pooled COC supernatants have been loaded on 10% SDS- polyacrilamide gel, electrophoresed at 80V for 2 hours and blotted onto PVDF membrane (Immobilon-P Millipore, Billerica, MA, USA) by electrotransfer at 100V for 45 minutes in 25mM Tris Buffer, 190mM Glycine, 2% SDS and 20% (V/V) Methanol. Blocking has been carried out with 5% nonfat dry milk, Tris 100mM pH7.5, NaCl 150mM over night at 4°C. After two washes, the membrane has been incubated with MEM-G1 moAb (Exbio, Praha, Czech Republic) (10µg/ml), which recognizes HLA-G molecule in denaturated form, for 3 hours at room temperature with gentle shaking. The sHLA-G molecules have been detected using Protein-G HRP (BioRad, Hercules, CA, USA) at dilution of 1:5000 in 10mM Tris pH8.0, 150mM NaCl, 0.1% Tween 20. Reactions have been developed by chemiluminescence with SuperSignal enhanced chemiluminescence kit (Super Signal West Pico system, Pierce, Rockford, IL, USA) and captured by Chemiluminescence Imaging Geliance 600 detection system (PerkinElmer, CT, USA). Soluble HLA-G molecules, purified as previously reported (sHLA-G ELISA Section), have been used as positive control, culture medium as negative control. The COC supernatants have been loaded at the same total protein concentration that has been evaluated by Quick Start Bradford protein assay (BioRad Laboratories, Hercules, CA, USA). The molecular weights have been determined with the BenchMark (Invitrogen, CA, US) pre-stained protein ladder (range 10-200 kD).

## **2.5 Statistics**

The Fisher's exact test has been used to analyze the different frequencies in sHLA-G positivities between COCs that generated mature or immature oocytes.

The Correlation Z test and the Regression test have been used to analyze the interpolation of ELISA and Bioplex standard curves.

The statistical analysis have been conducted using Stat View software package (SAS Institute Inc, Cary, NC, USA). P-value of 0.05 is considered significant (two tailed).

### **3. RESULTS**

#### **3.1 Comparison between the sHLA-G ELISA and the sHLA-G Bioplex assays**

We have compared the Bio-Plex assay and ELISA technique in quantifying sHLA-G molecules.

We have used the same capture antibody and standard reagents in both the techniques in order to maintain the same specificity. They have been compared for their sensitivity by geometric dilutions of the sHLA-G standard reagent. In Figure 1a and 1b the standard curves of the ELISA and Bio-Plex assays have been obtained with 50µl of standard reagent at the concentrations of 800, 500, 400, 300 pg/ml. The sensitivity has been calculated with repeated measurements of a negative control and a 3.29 standard deviation (SD) has been calculated (Anderson DJ, 1989) (Materials and Methods Section). We have interpolated the data in order to obtain a standard curve. The low limit of detection, corresponding to the 3.29 standard deviations (SD) added to the mean fluorescence (FI) or optical density value of the negative control, reached 300 pg/ml in the Bio-Plex assay and 600 pg/ml in the ELISA system.

We have observed a different accurateness of these two assays. As reported in Table 3, the Bio-Plex calibration curve described the standard data with the lowest error (mean error: 3.2%) in comparison to ELISA calibration curve (mean error: 25.7%) (Plikaytis *et al.*, 1991). The coefficient of variation (CV) for the Bio-Plex assay was 1.7 whereas the ELISA has presented a CV of 3.1. The statistical analysis of these two calibration curves has documented a higher correlation in the Bio-Plex standard curve in comparison with ELISA (Correlation Z test: Bio-Plex  $p < 0.0001$ ,  $r^2 = 0.9958$ ; ELISA  $p = 0.035$ ,  $r^2 = 0.9434$ ; Regression test Bio-Plex  $p = 0.0001$ ; ELISA  $p = 0.0287$ ).



The low CV, error and detection limit associated with the Bio-Plex test indicated us to select this assay to analyze the COC culture supernatants in order to reach lower sHLA-G levels with a higher degree of reliability in comparison with the ELISA system. The highest sensitivity of Bio-Plex assay is to be considered in comparison to our ELISA system and for low sHLA-G concentrations.

### **3.2 Detection of sHLA-G molecules in COC culture supernatants.**

We have analyzed the COC culture supernatants by means of Bio-Plex technology.

We have analyzed 152 COC supernatants from IVM procedures performed in 42 women. Among the COCs, 73 matured (metaphase II stage) and 79 remained immature (Prophase I or Metaphase I stage). Each woman had from one to three mature oocytes and from one to two immature oocytes.

We have revealed sHLA-G levels above 300 pg/ml in 14/73 (19%) COC supernatants that generated mature oocytes (Figure 2), in a range from 309 to 800 pg/ml, while no sHLA-G has been detected in COC supernatants corresponding to immature oocytes ( $p= 8.4 \times 10^{-5}$ ; Fisher exact test).

These results have documented the presence of sHLA-G molecules only in COCs that produced mature oocytes.

### **3.3 Western blot analysis**

We have confirmed the data obtained in COC supernatants by Bio-Plex technique with Western Blot analysis. In Figure 3 we have reported a representative Blot with a sHLA-G positive COC supernatant (second line) and a sHLA-G negative COC supernatant (third line), confirming the results obtained by Bio-Plex. We have considered the upper bands present in all the samples as aspecific positivities and the 37 kD positive band as HLA-G specific.

### **3.4 sHLA-G molecules and mature COC characteristics**

The variability in sHLA-G levels could be associated to different oocyte characteristics. We have evaluated the morphological feature of mature COCs (Table

1). Taking into consideration the surrounding cumulus cell feature, we have observed no differences in the percentage of sHLA-G positive supernatants in Grade A mature COCs (expanded cumulus) (9/43; 21%) in comparison to Grade B COCs (full or spare cumulus): (5/30; 17%) (p=NS, Fisher exact test) (Table 4; Figure 4a). Considering the polar body and cytoplasmic morphological characteristics of the mature oocytes (Metaphase II), evaluated after cumulus removal, we have observed a difference in the percentage of sHLA-G positive COC supernatants which correspond to Grade 1 oocytes (8/22; 36%) in comparison to Grade 2 (1/15; 7%) (p= 0.056, Fisher exact test) and Grade 3 (5/36; 14%). (p= 0.058, Fisher exact test) (Table 4; Figure 4b). The increased ability of COCs that generated Grade 1 oocytes to produce sHLA-G molecules is near the significant statistical p value, probably because of the low number of samples. However, the clear tendency of mature COCs with high score oocytes to produce more sHLA-G molecules, proposes these molecules as a marker of oocyte grade. Therefore it will be mandatory to increase the number of analyzed COCs in order to confirm this observation.

### ***3.5 sHLA-G molecules in mature COC culture supernatants subdivided into women***

In order to identify a possible different sHLA-G production between the mature COCs of the same woman, we have subdivided them between women (Figure 5a). The 14 supernatants with a sHLA-G positivity corresponded to 13 different women. Taking into consideration the women with at least one sHLA-G positive COC culture, we have observed different sHLA-G levels in their COC supernatant. For example, in Figure 5a, the woman number 1 presents two COC supernatants with no sHLA-G and one with 410 pg/ml of sHLA-G; woman number 10 has all the three COC cultures negative for sHLA-G detection.

The women have presented different sHLA-G levels when we have compared COC supernatants between women. These data are of great interest because it seems that the COCs could be characterized by a different ability to produce HLA-G molecules.

Taking into consideration the previous results on oocyte morphology and differences in sHLA-G modulation, we have analyzed if the differences in sHLA-G levels between women could be correlated to different oocyte Grades. In Figure 5b we have reported 10 representative women. There is an association between the differences observed in sHLA-G levels and the oocyte Grades. The woman number 1 has two COC supernatant without sHLA-G classified as Grade 3 (white), and Grade 2 (grey) and one with 410 pg/ml of sHLA-G (Grade 1 oocyte, black); woman number 10 has all the three COC cultures negative for sHLA-G and Grade 3 oocytes.

#### **4. DISCUSSION**

The reduction of the number of fertilized oocytes and transferred embryos represents the main target of assisted reproductive medicine. During recent years, several studies have suggested a relationship between the production of sHLA-G molecules by early embryos and an increased implantation rate in IVF protocols (Fuzzi *et al.*, 2002; Roussev *et al.*, 2003; Sher *et al.*, 2004; Criscuoli *et al.*, 2005; Noci *et al.*, 2005; Sher *et al.* 2005a; Sher *et al.* 2005b; Yie *et al.*, 2005; Desai *et al.*, 2006; Fisch *et al.*, 2007; Rebmann *et al.*, 2007; Rizzo *et al.*, 2007). Two studies (van Lierop *et al.*, 2002 Sageshima *et al.*, 2007) have failed to detect sHLA-G molecules in embryo culture supernatants, probably due to technical discrepancies, as suggested by the recent review by Warner *et al.* (Warner *et al.*, 2008). It is important to develop a very high quality level in sHLA-G detection methodology, to overcome these problems in order to evaluate the exact amount of sHLA-G produced by an in vitro cultured embryo (Menezo *et al.*, 2006) and to establish the functional role of sHLA-G during early embryo development (Apps *et al.*, 2008). However the data obtained by twelve researches suggest the production of sHLA-G as a potential marker of embryo implantation. Surely, it is still mandatory to evaluate embryo morphological parameters for an accurate embryo selection.

Oocytes obtained under ovarian stimulation present a variable competence and although molecular approaches have been proposed (Coticchio *et al.*, 2004; Patrizio *et al.*, 2007) the selection is still performed on morphological characteristics. Recently, the presence of sHLA-G molecules in a percentage of FFs and a significant association with the production of these antigens by the corresponding fertilized oocyte was reported (Rizzo *et al.*, 2007). Shaikly and coauthors (Shaikly *et al.*, 2008) have confirmed the presence of sHLA-G molecules in FFs but they have failed to identify the correlation with early embryo sHLA-G production. Several differences in embryo culture conditions and in the technical procedures to detect sHLA-G could justify the different results obtained by these two studies. The presence of sHLA-G in FFs is not a confirmation that it is important in oocyte maturation but it seems to be a marker of embryo competency. However, further studies are required to confirm the relationship between FFs and embryo sHLA-G production. The goal of this study was to identify if sHLA-G could be also a marker of oocyte maturation. The oocyte maturity has been demonstrated to be important in producing good quality blastocysts for embryo transfer (Huang *et al.*, 2002) and molecular markers to define oocyte maturity would be of great interest together with morphological characterization. A sHLA-G assay based on Luminex technology reaching a detection limit of 300 pg/ml has been proposed (Rebmann *et al.*, 2007). We have developed a similar Bio-Rad's Bio-Plex system reaching the same limit of sensitivity.

Our results show that the COCs produce sHLA-G molecules during oocyte maturation process. The main point is that no sHLA-G molecules have been detected in the COC culture supernatants corresponding to immature oocytes. Some COCs have produced mature oocytes but no sHLA-G have been observed in their supernatants, underlining that sHLA-G is only one of the factor implicated in this process. Overall these results suggest a variable production of sHLA-G molecules in association with a different oocyte maturation. sHLA-G production have been related to the morphological characteristics of mature COCs in order to analyze the possible functional role of these differences. All the mature COCs have been classified

accordingly to their granulosa cell morphology, and to the oocyte cytoplasm and polar body characteristics before insemination. Taking into consideration the surrounding cumulus cell feature, we have observed similar percentages of sHLA-G positive supernatants in Grade A and Grade B mature COCs (Figure 4a). On the contrary, the classification using polar body and cytoplasm characteristics has demonstrated a tendency of Grade 1 mature oocytes to produce sHLA-G molecules higher than Grade 2 and Grade 3 oocytes (Figure 4b). This association could propose sHLA-G as a marker to identify high score mature oocytes. It will be mandatory to increase the number of analyzed oocytes in order to confirm our observation based on a statistical significance near the limit p value. The analysis of sHLA-G concentrations in mature COCs between women have shown different sHLA-G levels both in mature COCs from the same woman and in mature COCs from different women. These data confirm that COCs could be characterized by a different ability to produce sHLA-G molecules that is associated with the different oocyte grade. Further analyses are required to define the mechanisms that influence sHLA-G production and the role of this antigen as directly implicated in oocyte maturation or as a marker of COC metabolism. A metabolic cooperation between oocyte and the surrounding granulosa cells is required for a complete maturation. The absence of sHLA-G molecules in immature COCs could suggest a role for these molecules in oocyte maturation. It is known that cumulus cells express innate immune related genes (CD14, Toll like receptors) (Liu *et al.*, 2008) that may play critical roles in surveillance and cell survival during the ovulation process and HLA-G could be one of these mechanisms. sHLA-G could be important in the maintenance of a balance between pro - and anti – inflammatory effectors and the absence of this molecule in COC supernatants could identify a difficulty in creating the correct maturation microenvironment.

In conclusion, these data demonstrate for the first time the ability of mature COCs to produce detectable amounts of sHLA-G molecules. This production could be a marker of good quality oocyte maturation and it could be used to select the best

oocyte to be fertilized in addition to the morphological approaches in order to reduce the number of produced and transferred embryos.

### **Acknowledgment**

We thank Dr. Amanda Neville for writing assistance.

### **REFERENCES**

- Anderson, DJ., 1989. Determination of the lower limit of detection. *Clinical Chemistry* 35, 2152-2153.
- Apps, R., Gardner, L., Moffett, A., 2008. A critical look at HLA-G. *Trends Immunol* 29, 313-321.
- Bainbridge, D.R., Ellis, S.A., Sargent, I.L., 2000. HLA-G suppresses proliferation of CD4(+) T-lymphocytes. *J. Reprod. Immunol.* 48, 17-26.
- Cillo, F., Brevini, T.A., Antonini, S., Paffoni, A., Ragni, G., Gandolfi, F., 2007. Association between human oocyte developmental competence and expression levels of some cumulus genes. *Reprod.* 134, 645-650.
- Combelles, C.M., Cekleniak, N.A., Racowsky, C., Albertini, D.F., 2002, Assessment of nuclear and cytoplasmic maturation in in-vitro matured human oocytes. *Hum. Reprod.* 17, 1006-1016.
- Coticchio, G., Sereni, E., Serrao, L., Mazzone, S., Iadarola, I., Borini, A., 2004. What criteria for the definition of oocyte quality? *Ann. N. Y. Acad. Sci.* 1034, 132–144.
- Criscuoli, L., Rizzo, R., Fuzzi, B., Melchiorri, L., Menicucci, A., Cozzi, C., Dabizzi, S., Branconi, F., Evangelisti, P., Baricordi, O.R., Noci, I., 2005. Lack of Histocompatibility Leukocyte Antigen-G expression in early embryos is not related to germinal defects or impairment of interleukin-10 production by embryos. *Gynecol. Endocrinol.* 20, 264-269.
- Desai, N., Filipovits, J., Goldfarb, J., 2006. Secretion of soluble HLA-G by day 3 human embryos associated with higher pregnancy and implantation rates: assay of culture media using a new ELISA kit. *Reprod. Biomed. Online* 13, 272-277.

- Elvin, J.A., Clark, A.T., Wang, P., Wolfman, N.M., Matzuk, M.M., 1999. Paracrine actions of growth differentiation factor-9 in the mammalian ovary. *Mol. Endocrinol.* 13, 1035-1048.
- Eppig, J.J., 1991. Intercommunication between mammalian oocytes and companion somatic cells. *Bioessays* 13, 569-574.
- Feger, U., Tolosa, E., Huang, Y.H., Waschbisch, A., Biedermann, T., Melms, A., Wiendl, H., 2007. HLA-G expression defines a novel regulatory T-cell subset present in human peripheral blood and sites of inflammation. *Blood* 110, 568-577.
- Feuerstein, P., Cadoret, V., Dalbies-Tran, R., Guerif, F., Bidault, R., Royere, D., 2007. Gene expression in human cumulus cells: one approach to oocyte competence. *Hum. Reprod.* 22, 3069-3077.
- Fineschi, V., Neri, M., Turillazzi, E., 2005. The new Italian law on assisted reproduction technology. *J. Med. Ethics.* 31, 536-539.
- Fisch, J.D., Keskinetepe, L., Ginsburg, M., Adamowicz, M., Sher, G., 2007. Graduated Embryo Score and soluble human leukocyte antigen-G expression improve assisted reproductive technology outcomes and suggest a basis for elective single-embryo transfer. *Fertil. Steril.* 87, 757-763.
- Fournel, S., Aguerre-Girr, M., Huc, X., Lenfant, F., Alam, A., Toubert, A., Bensussan, A., Le Bouteiller, P., 2000. Cutting edge: soluble HLA-G1 triggers CD95/CD95 ligand-mediated apoptosis in activated CD8<sup>+</sup> cells by interacting with CD8. *J. Immunol.* 164, 6100-6104.
- Fuzzi, B., Rizzo, R., Criscuoli, L., Noci, I., Melchiorri, L., Scarselli, B., Bencini, E., Menicucci, A., Baricordi, O.R., 2002. HLA-G expression in early embryos is a fundamental prerequisite for the obtainment of pregnancy. *Eur. J. Immunol.* 32, 311-315.
- Gilchrist, R.B., Ritter, L.J., Armstrong, D.T., 2004. Oocyte-somatic cell interactions during follicle development in mammals. *Anim. Reprod. Sci.* 82-83, 431-446.

- Huang, F.J., Huang, H.W., Lan, K.C., Kung, F.T., Lin, Y.C., Chang, H.W., Chang, S.Y., 2002. The maturity of human cumulus-free oocytes is positively related to blastocyst development and viability. *J. Assist. Reprod. Genet.* 19, 555-560.
- Khalil-Daher, I., Riteau, B., Menier, C., Menier, C., Sedlik, C., Paul, P., Dausset, J., Carosella, E.D., Rouas-Freiss, N., 1999. Role of HLA-G versus HLA-E on NK function: HLA-G is able to inhibit NK cytotoxicity by itself. *J. Reprod. Immunol.* 43, 175-182.
- LeFric, G., Laupeze, B., Fardel, O., Sebti, Y., Pangault, C., Guilloux, V., Beauplet, A., Fauchet, R., Amiot, L., 2003. Soluble HLA-G inhibits human dendritic cell-triggered allogeneic T-cell proliferation without altering dendritic differentiation and maturation processes. *Hum. Immunol.* 64, 752-761.
- LeGal, F.A., Riteau, B., Sedlik, C., Khalil-Daher, I., Menier, C., Dausset, J., Guillet, J.G., Carosella, E.D., Rouas-Freiss, N., 1999. HLA-G mediated inhibition of antigen-specific cytotoxic T lymphocytes. *Int. Immunol.* 11: 1351-1356.
- Lila, N., Rouas-Freiss, N., Dausset, J., Carpentier, A., Carosella, E.D., 2001. Soluble HLA-G protein secreted by allo-specific CD4<sup>+</sup> T cells suppresses the allo-proliferative response: a CD4<sup>+</sup> T cell regulatory mechanism. *Proc. Natl. Acad. Sci. USA.* 98, 12150-12155.
- Liu Z., Shimada M., Richards JS., 2008. The involvement of the Toll-like receptor family in ovulation. *J. Assist. Reprod. Genet.* 25, 223-228.
- Moffett, A., Loke, C., 2006. Immunology of placentation in eutherian mammals. *Nat Rev Immunol.* 6, 584-594.
- Menezo, Y., Elder, K., Viville, S., 2006. Soluble HLA-G release by the human embryo: an interesting artefact? *Reprod. Biomed. Online.* 13, 763-764.
- Noci, I., Fuzzi, B., Rizzo, R., Melchiorri, L., Criscuoli, L., Dabizzi, S., Biagiotti, R., Pellegrini, S., Menicucci, A., Baricordi, OR., 2005. Embryonic soluble HLA-G as a marker of developmental potential in embryos. *Hum. Reprod.* 20, 138-146.
- Patrizio, P., Fragouli, E., Bianchi, V., Borini, A., Wells, D., 2007. Molecular methods for selection of the ideal oocyte. *Reprod. Biomed. Online* 15, 346-353.



Plikaytis, B.D., Turner, S.H., Gheesling, L.L., Carlone GM., 1991. Comparisons of standard curve-fitting methods to quantitate *Neisseria meningitidis* group A polysaccharide antibody levels by enzyme-linked immunosorbent assay. *J Clin Microbiol.* 29, 1439-1446.

Rebmann, V., Lemaout, J., Rouas-Freiss, N., Carosella, E.D., Grosse-Wilde, H., 2005. Report of the Wet Workshop for quantification of soluble HLA-G in Essen. *Human Immunol.* 66, 853–863.

Rebmann, V., Switala, M., Eue, I., Schwahn, E., Merzenich, M., Grosse-Wilde, H., 2007. Rapid evaluation of soluble HLA-G levels in supernatants of in vitro fertilized embryos. *Human Immunol.* 68, 251-258.

Rizzo, R., Fuzzi, B., Stignani, M., Criscuoli, L., Melchiorri, L., Dabizzi, S., Campioni, D., Lanza, F., Marzola, A., Branconi, F., Noci, I., Baricordi, O.R., 2007. Soluble HLA-G molecules in follicular fluid: a tool for oocyte selection in IVF? *J Reprod Immunol* 74, 133-142.

Rouas-Freiss, N., Goncalves, R.M., Menier, C., Dausset, J., Carosella, E.D., 1997. Direct evidence to support the role of HLA-G in protecting the fetus from maternal uterine natural killer cytotoxicity. *Proc. Natl. Acad. Sci. USA.* 94, 11520-11525.

Rouas-Freiss, N., Naji, A., Durrbach, A., Carosella, E.D., 2007. Tolerogenic functions of human leukocyte antigen G: from pregnancy to organ and cell transplantation. *Transplantation* 84, S21-25.

Roussev, R.G., Keskinetepe, L., Coulam, C.B., 2003. Soluble HLA-G (sHLA-G) in human embryo culture media: a useful marker for assessing embryo quality and implantation potential for IVF. *Fertil. Steril.* 80, S12-13.

Sageshima, N., Shobu, T., Awai, K., Hashimoto, H., Yamashita, M., Takeda, N., Odawara, Y., Nakanishi, M., Hatake, K., Ishitani, A., 2007. Soluble HLA-G is absent from human embryo cultures: a reassessment of sHLA-G detection methods. *J. Reprod. Immunol.* 75, 11-22.

Selmani, Z., Naji, A., Zidi, I., Favier, B., Gaiffe, E., Obert, L., Borg, C., Saas, P., Tiberghien, P., Rouas-Freiss, N., Carosella, E.D., Deschaseaux, F., 2008. Human leukocyte antigen-G5 secretion by human mesenchymal stem cells is required to

suppress T lymphocyte and natural killer function and to induce CD4<sup>+</sup>CD25<sup>high</sup>FOXP3<sup>+</sup> regulatory T cells. *Stem Cells* 26, 212-222.

Shaikly, V.R., Morrison, I.E., Taranissi, M., Noble, C.V., Withey, A.D., Cherry, R.J., Blois, S.M., Fernández, N., 2008. Analysis of HLA-G in Maternal Plasma, Follicular Fluid, and Preimplantation Embryos Reveal an Asymmetric Pattern of Expression. *J Immunol* 180, 4330-4337.

Sher, G., Keskinetepe, L., Nouriani, M., Roussev, R., Batzofin, J., 2004. Expression of sHLA-G in supernatants of individually cultured 46-h embryos: a potentially valuable indicator of 'embryo competency' and IVF outcome. *Reprod. Biomed. Online* 9, 74-78.

Sher, G., Keskinetepe, L., Batzofin, J., Fisch, J., Acacio, B., Ahlering, P., Ginsburg, M., 2005a. Influence of early ICSI-derived embryo sHLA-G expression on pregnancy and implantation rates: a prospective study. *Hum. Reprod.* 20, 1359-1363.

Sher, G., Keskinetepe, L., Fisch, J.D., Acacio, B.A., Ahlering, P., Batzofin, J., Ginsburg, M., 2005b. Soluble human leukocyte antigen G expression in phase I culture media at 46 h after fertilization predicts pregnancy and implantation from day 3 embryo transfer. *Fertil. Steril.* 83, 1410-1414.

Van Lierop, M.J., Wijnands, F., Loke, YW., Emmer, P.M., Lukassen, H.G., Braat, D.D., van der Meer, A., Mosselman, S., Joosten, I., 2002. Detection of HLA-G by a specific sandwich ELISA using monoclonal antibodies G233 and 56B. *Mol. Hum. Reprod.* 8, 776-784.

Warner, C.M.; Lampton, P.W., Newmark, J.A., Cohen, J., 2008. Soluble human leukocyte antigen-G and pregnancy success. *Reprod. Biomed. Online.* 17, 470-485.

Yie, S.M., Balakier, H., Motamedi, G., Librach, C.L., 2005. Secretion of human leukocyte antigen-G by human embryos is associated with a higher in vitro fertilization pregnancy rate. *Fertil. Steril.* 83, 30-36.

**Table 1**

Details of in vitro maturation procedure.

	<b>Women (n=42)</b>
Age (years) (mean $\pm$ SD)	35 $\pm$ 3
Number of recovered oocytes per woman (mean $\pm$ SD)	7 $\pm$ 1
Mature oocytes per woman (%)	20 – 50

**Table 2**

Mature COC (a) and oocyte (b) grade scoring.

a)

<b>MATURE COC GRADE</b>	<b>CUMULUS</b>	<b>ADHESION TO OOCYTE</b>
GRADE A	EXPANDED MULTILAYER	FULL
GRADE B	FULL / SPARE ONE – THREE LAYERS	SPARE

b)

<b>MATURE OOCYTE GRADE</b>	<b>CYTOPLASMATIC</b>	<b>POLAR BODY</b>
GRADE 1	HOMOGENOUS	ROUND
GRADE 2	GRANULAR	ROUND
GRADE 3	GRANULAR	FRAGMENTED/ IRREGULAR

**Table 3**

Calculated standard concentrations from ELISA (a) and BioPlex (b) assays

a)

<b>Standard Conc (pg/ml)</b>	<b>Calculated Conc* (pg/ml)</b>	<b>%Error<sup>†</sup></b>
800	1035	29.4
500	535	7.0
400	485	21.3
300	435	45.0
<b>Mean error (%)</b>		<b>25.7</b>

b)

<b>Standard Conc (pg/ml)</b>	<b>Calculated Conc* (pg/ml)</b>	<b>%Error<sup>†</sup></b>
800	798	0.3
500	514	2.6
400	379	5.0
300	315	5.0
200	195	3.0
<b>Mean error (%)</b>		<b>3.2</b>

\* For the calculated standard concentrations we used the regression curve equations. The  $r^2$  values were 0.9434 and 0.9958 for ELISA and BioPlex assays respectively.

<sup>†</sup>% Error, absolute value  $\{[(\text{calculated concentration} - \text{standard concentration}) / \text{standard concentration}] \times 100\}$

**Table 4**

Subdivision of mature oocytes accordingly to COC and oocyte grading and sHLA-G production.

	<b>Mature oocyte (n=73)</b>	<b>sHLA-G + (n=14)</b>
<b>COC Grade</b>		
<b>Grade A</b>	43	9
<b>Grade B</b>	30	5
<b>Oocyte Grade</b>		
<b>Grade 1</b>	22	8
<b>Grade 2</b>	15	1
<b>Grade 3</b>	36	5

### *Legends to figures*

#### **Figure 1**

ELISA (a) and Bio-Plex (b) standard curves (Black line). They have been obtained with 50µl of standard reagent at the concentrations of 800, 500, 400, 300 pg/ml. The detection limit, 3.29 SD added to the mean optical density (OD) or fluorescence (FI) of repeated negative control (culture medium) measurements, is reported (Dotted line). The bold line indicates the linear regression and the dashed lines the 95% confidence interval.

The  $r^2$  values were 0.9434 and 0.9958 for the ELISA and Bioplex assays respectively and the CV values were 3.1 and 1.7 respectively.

**Figure 2**

sHLA-G levels in 73 COC culture supernatants that generated mature oocytes. The detection limit, 3.29 SD added to the mean fluorescence (FI) of repeated negative control (culture medium) measurements, is reported (Dotted line).

**Figure 3**

Western Blot analysis of COC supernatants positive (O1) or negative (O2) for sHLA-G detection by Bioplex system. Anti HLA-G1/HLA-G5 MEM-G1 MoAb has been used for the detection. HLA-G purified molecules have been used as positive control (+), culture medium as negative control (-). The COC supernatants have been loaded at the same total protein concentration that has been evaluated by Quick Start Bradford protein assay (Bio-Rad Laboratories, Hercules, CA, USA). The molecular weights (Mk) have been determined with the BenchMark (Invitrogen, CA, US) pre-stained protein ladder (range 10-200 kD).

**Figure 4**

sHLA-G levels in mature COC supernatants subdivided accordingly to a) COC feature (Grade A and Grade B); b) characterization of oocyte polar body and cytoplasm (Grade 1, Grade 2 and Grade 3). The detection limit, 3.29 SD added to the mean fluorescence (FI) of repeated negative control (culture medium) measurements, is reported (Dotted line).

**Figure 5**

sHLA-G levels in mature COC supernatants subdivided into women (a) and in 10 representative women with oocyte Grade (Grade 1 (black); Grade 2 (grey) and Grade 3 (white)). The detection limit, 3.29 SD added to the mean fluorescence (FI) of repeated negative control (culture medium) measurements, is reported (Dotted line).

Figure 1

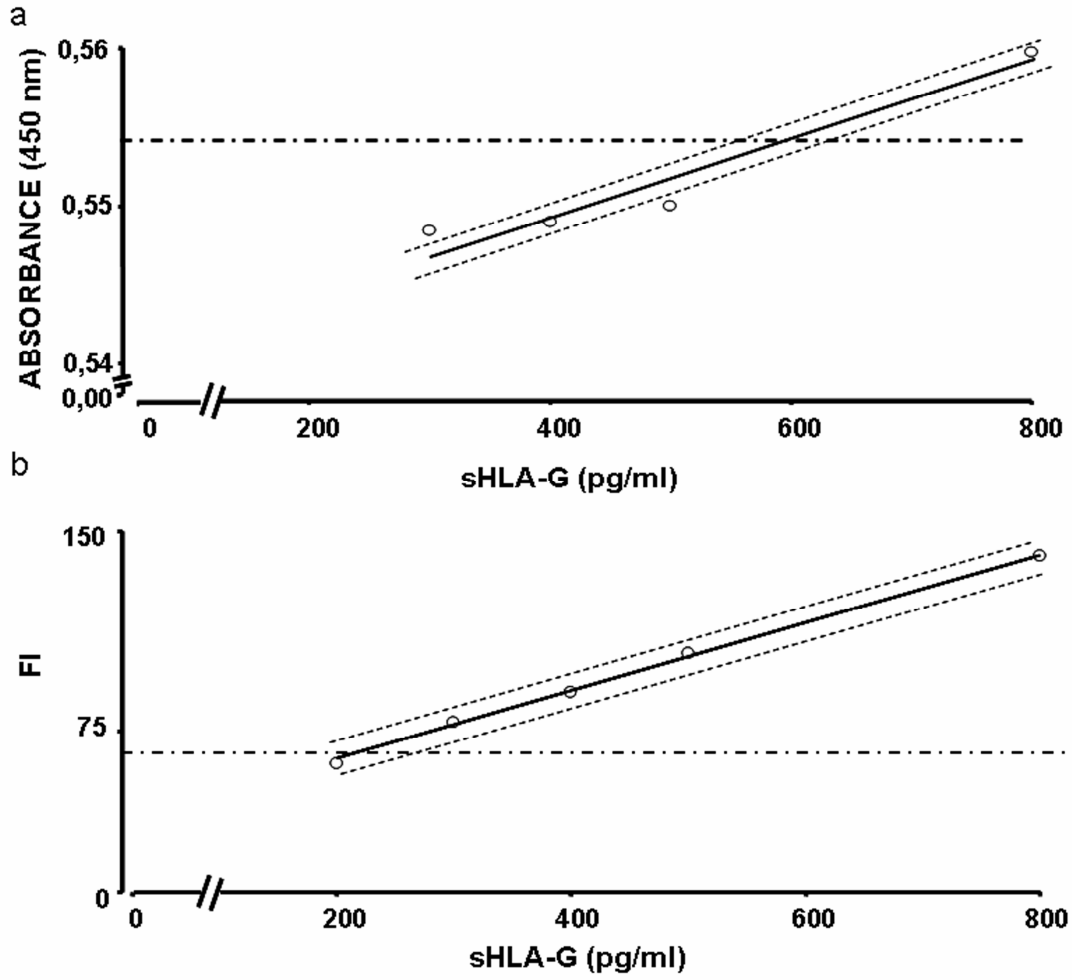
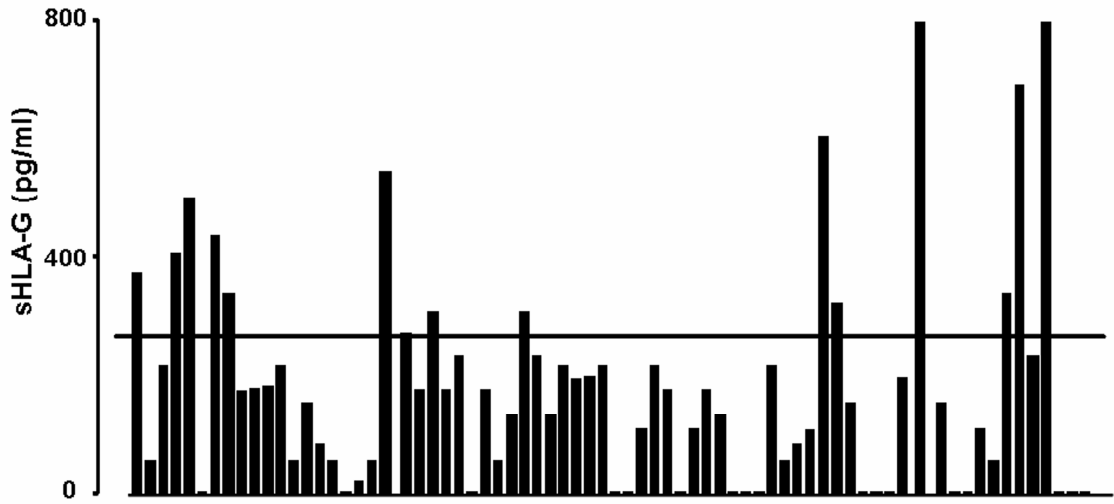
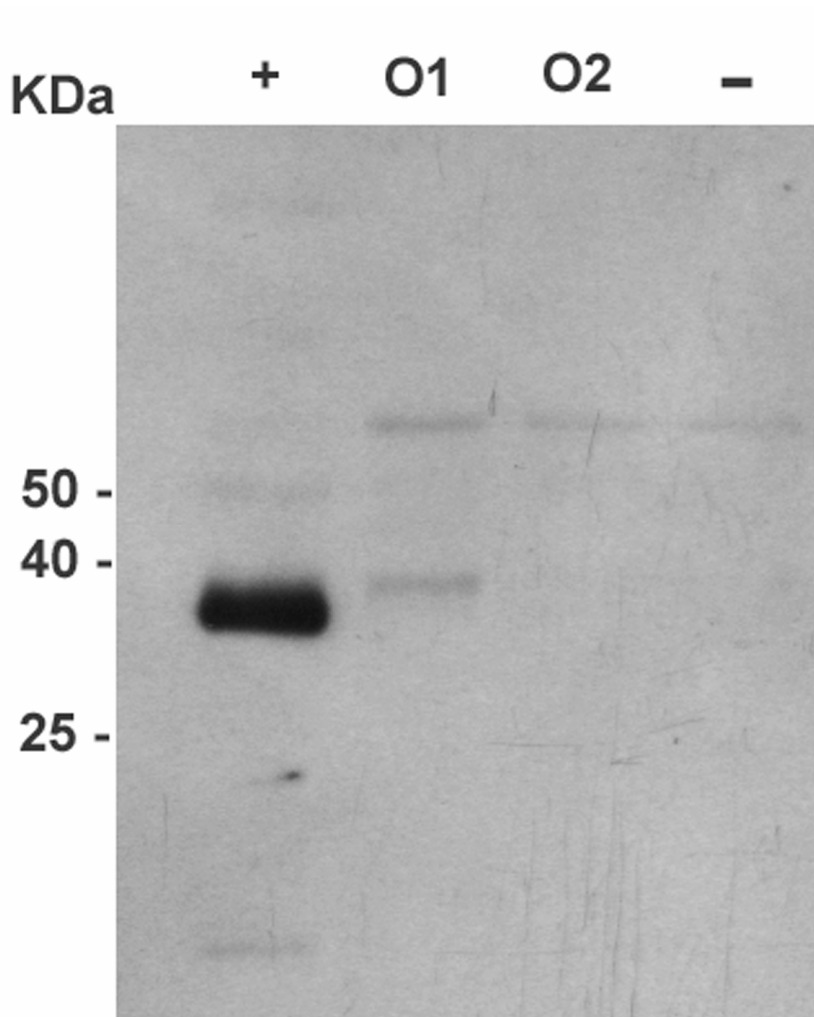



Figure 2



**Figure 3**



**Figure 4**

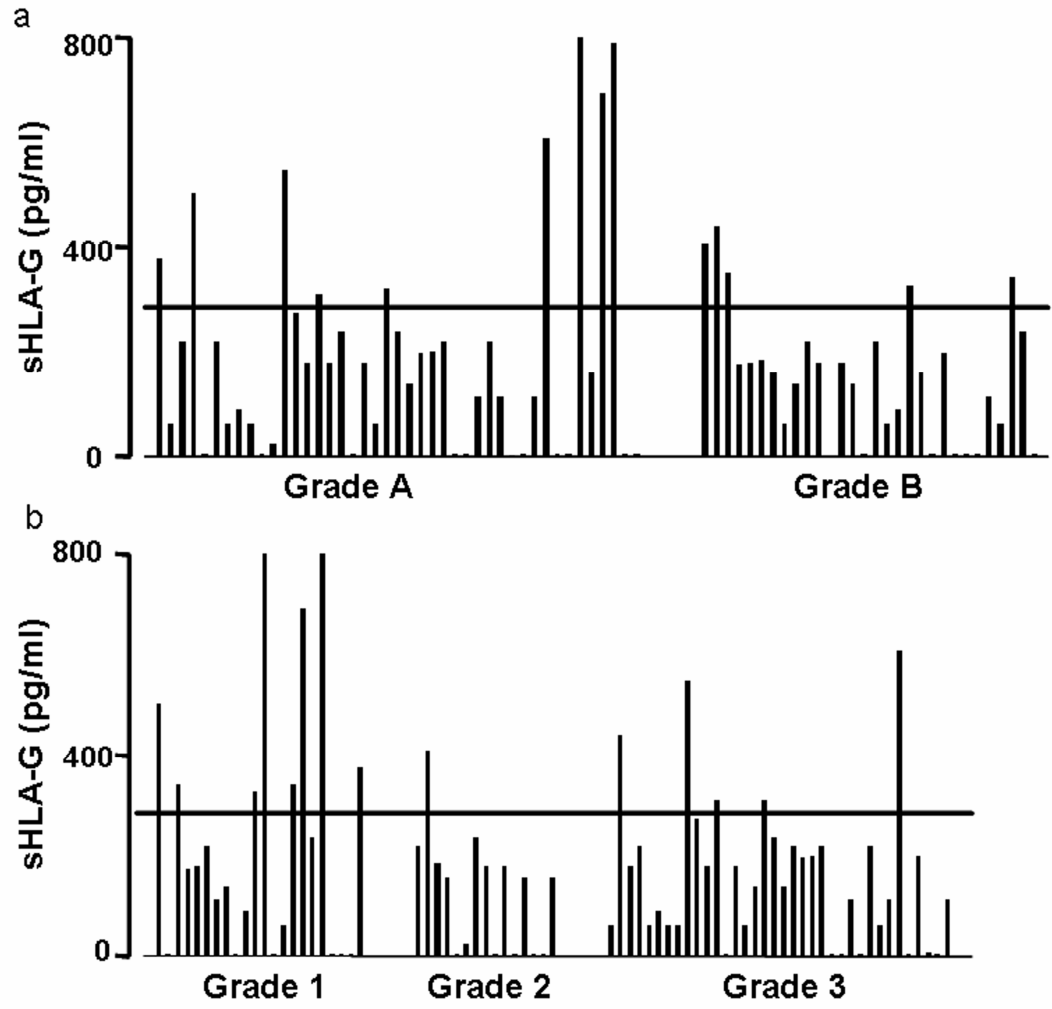

**Figure 5**

